

Alloy Wheels Protector INSTALLATION INSTRUCTIONS All Models

Part number 08873-80010

Revision Record

Rev. No.	Date	Page	Picture	Update	New	Deleted
1	08-04-2013	4			MSDS	

A



1x

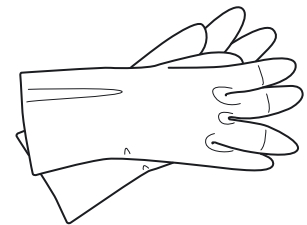
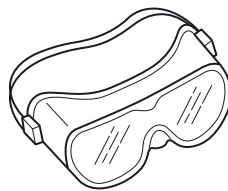
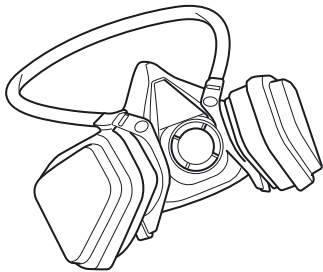

(3x) Microfibre





<http://your.msds.be>
 login: **TMME**
 password: **MSDS**

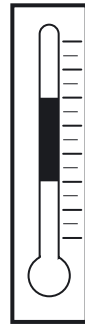

+35°C ✓
 +4°C

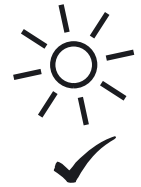

min.
500 lx

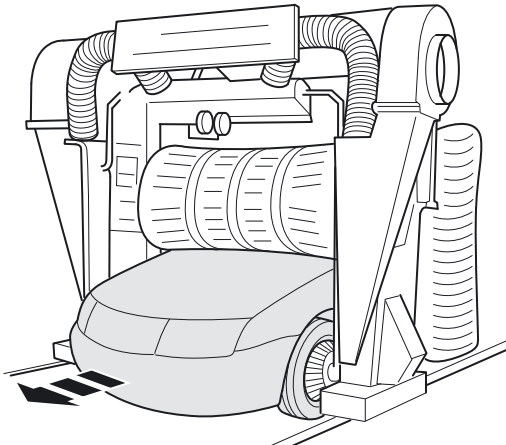
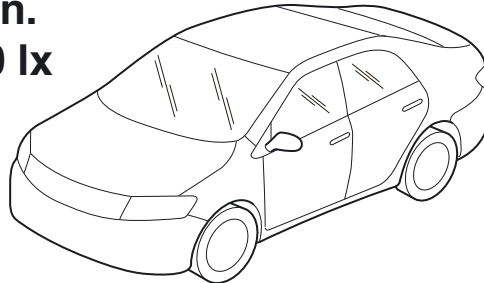
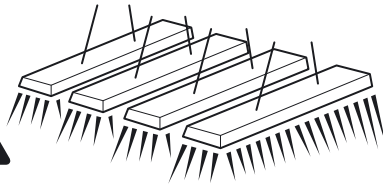

1

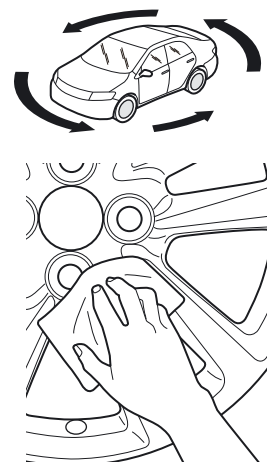
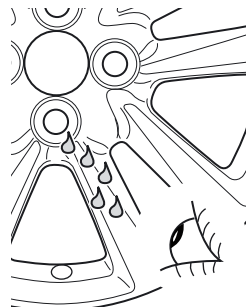

1

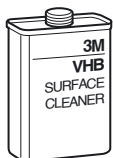

2

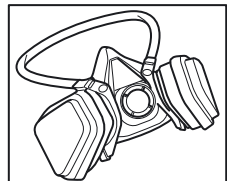
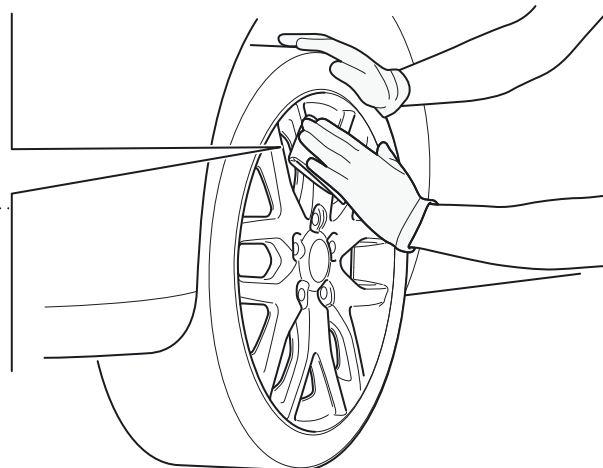

2

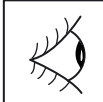

Page 7 of 7
Alloy Wheels Protector
CHECK SHEET (I)

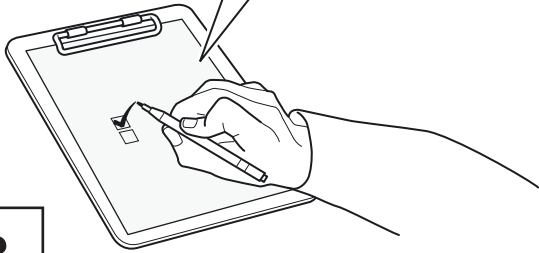

3

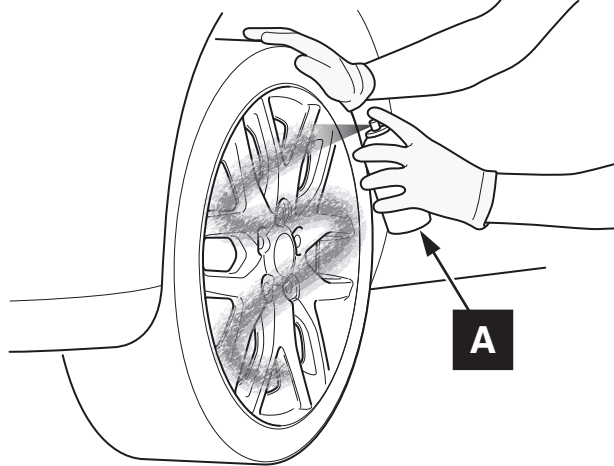
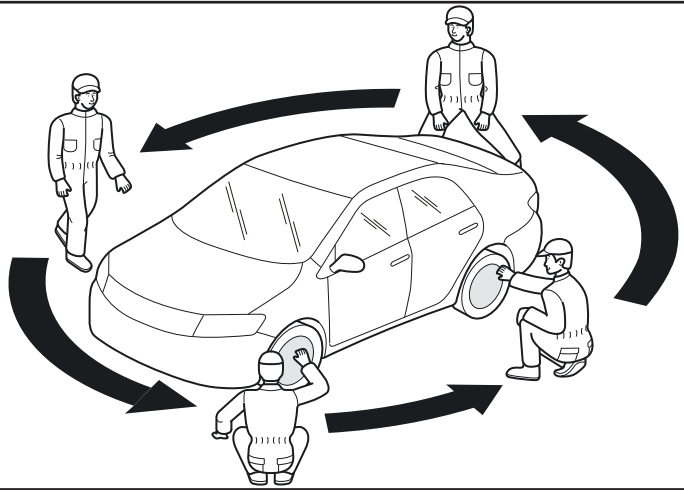

4

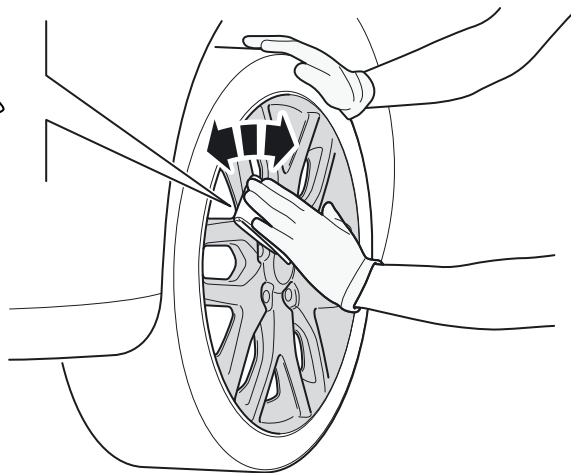
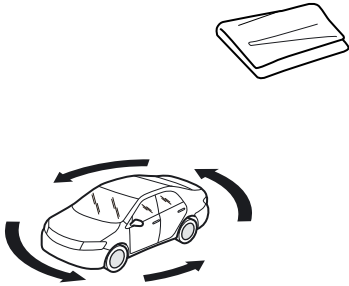
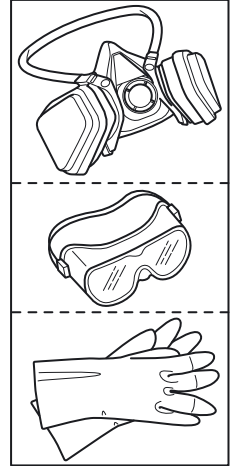

5

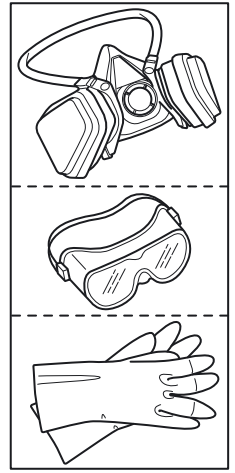

Page 7 of 7
Alloy Wheels Protector
CHECK SHEET (II)



6

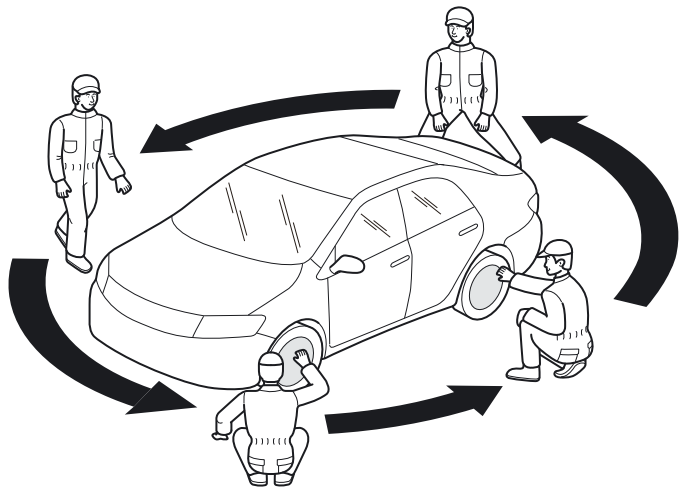

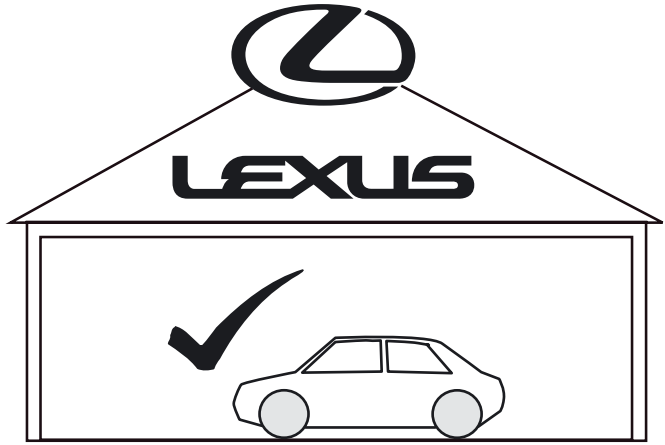

7

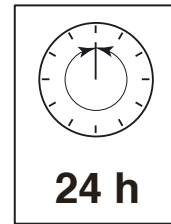
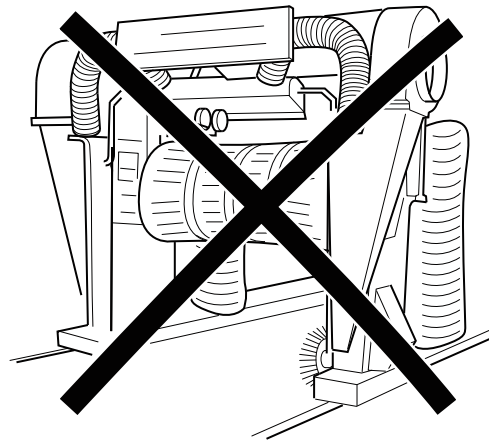
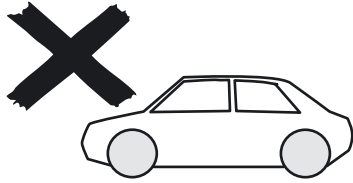

8



Alloy Wheels Protector CHECK SHEET

Dealer Name

Technician

Date

. . / . . /

VIN n°

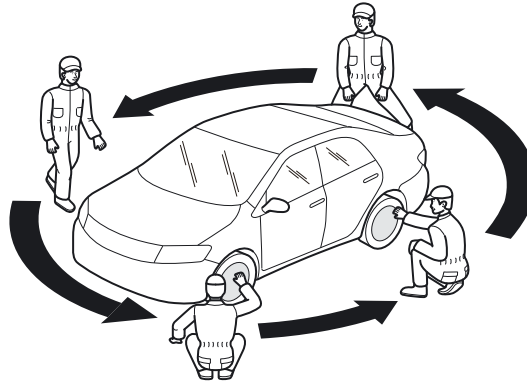

I. After degrease

dry, no damage and clean

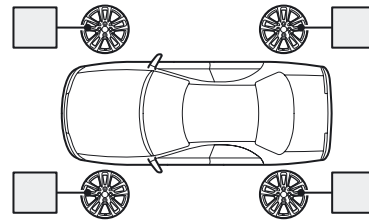
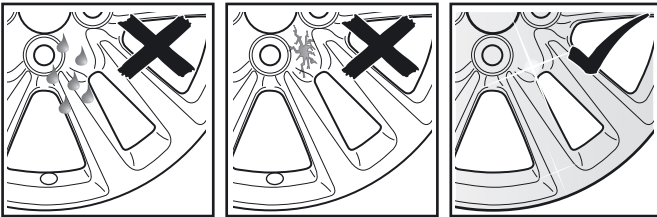

II. After wipe

smooth on all areas

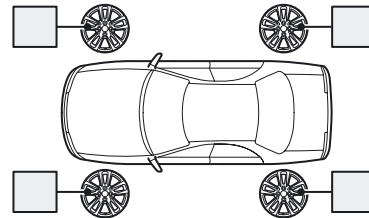
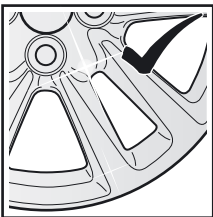

Signature

Stamp

