

Wind deflector INSTALLATION INSTRUCTIONS RX-L

Model year	As from 2017/12
Vehicle code	**L2**-A****W
Part number	08162-48820

Revision Record

Rev. No.	Date	Page	Steps	Remarks
△ ₁	29-05-19	1, 11		Model year added
△ ₂	14-04-20	1,11		Model name updated

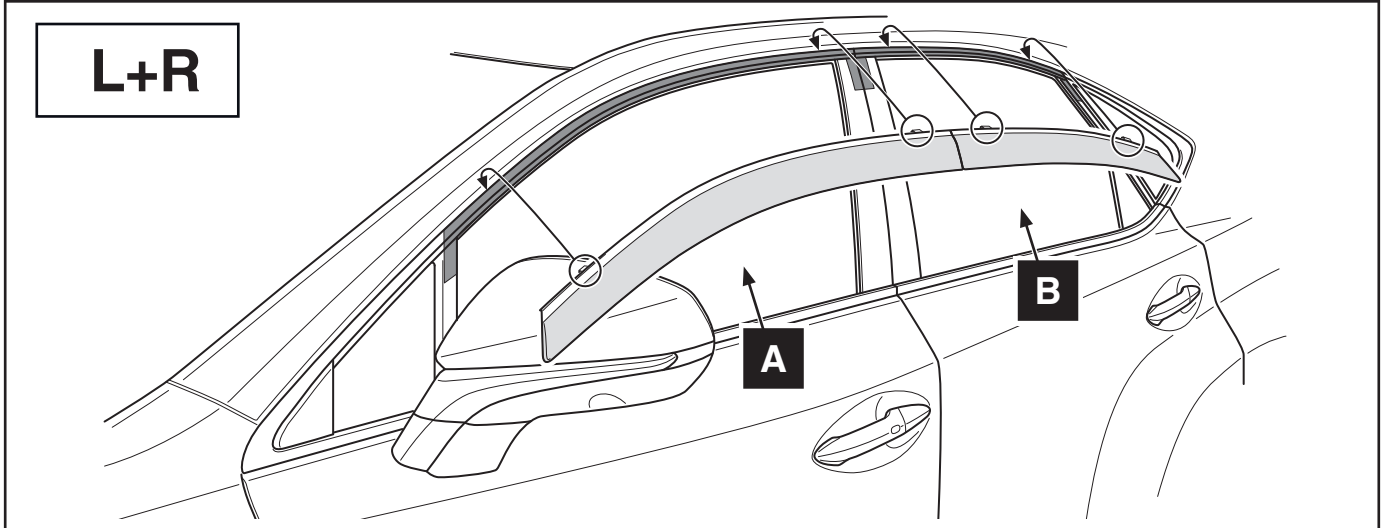
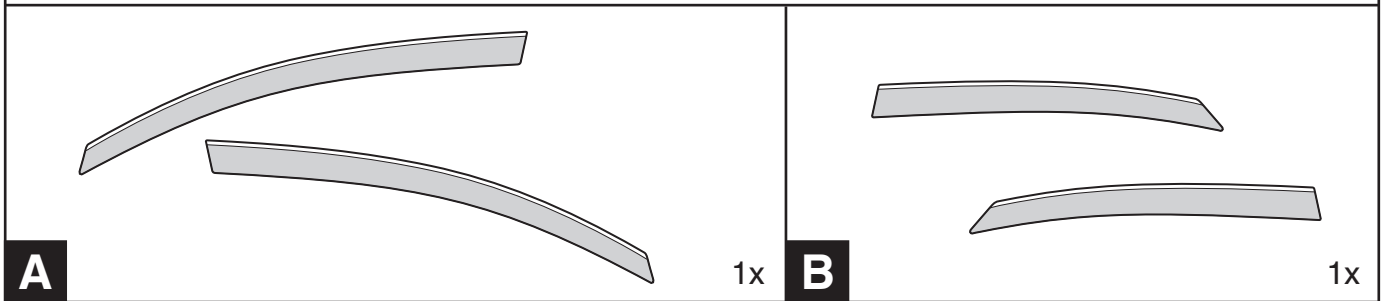

		<p>AIM 003-517-*</p>		
			<p>3M adhesion promoter PZ415-00000-00</p>	

INFO



Material **S**afety **D**ata **S**heet







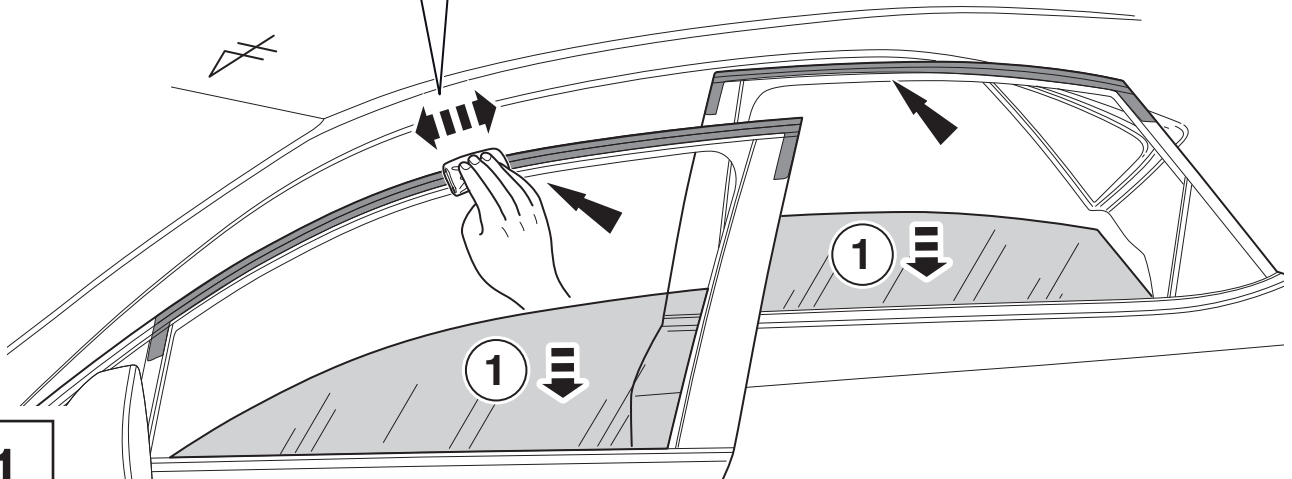
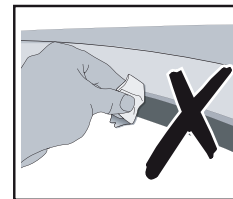
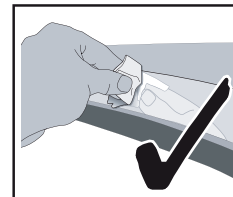
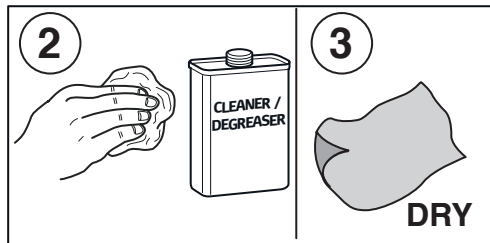
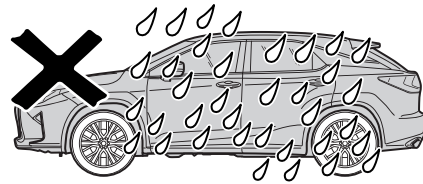
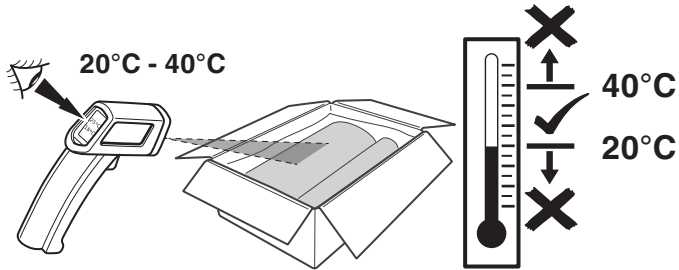
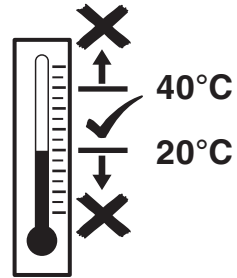
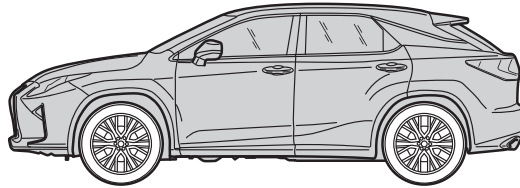

Technical **D**ata **S**heet

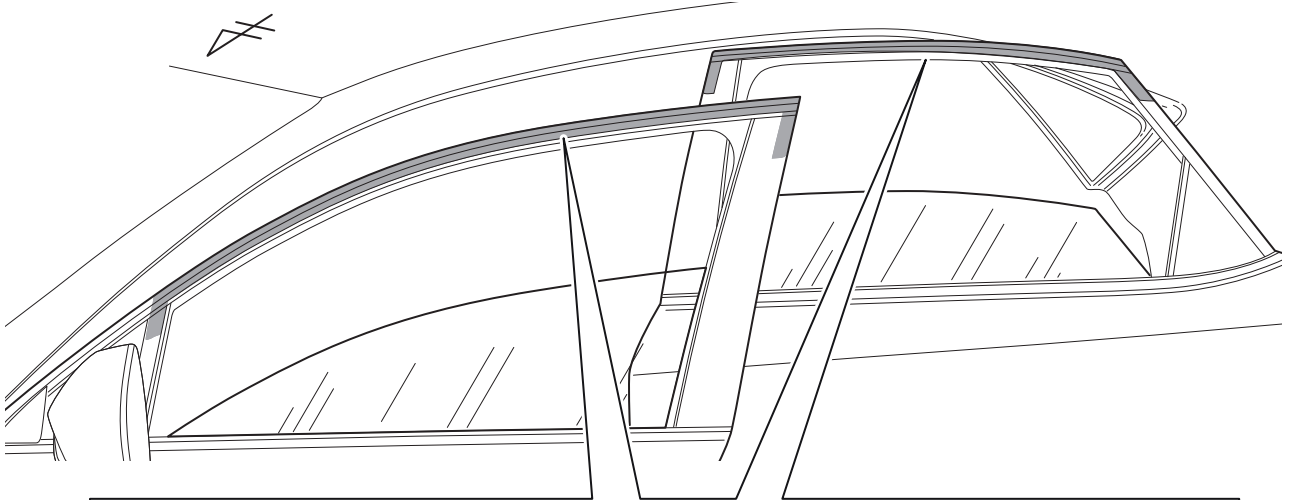
20°C - 40°C

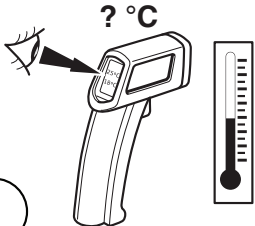
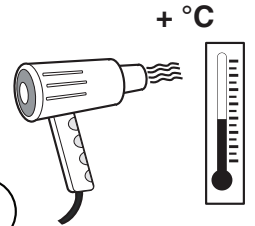
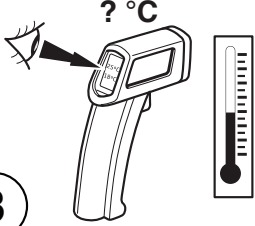





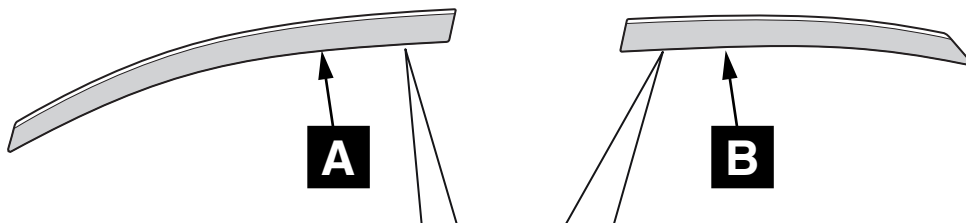

1

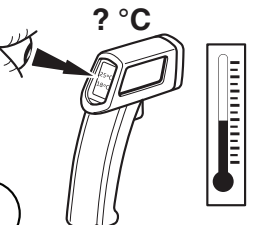
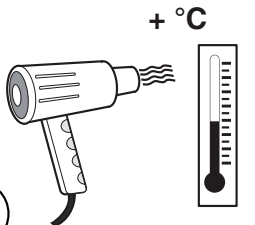
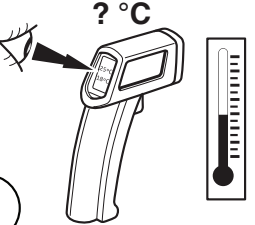

2	 1	$< 20^{\circ}\text{C}$ → 2 $20^{\circ}\text{C} - 40^{\circ}\text{C}$ → 3	 2
	 3	$20^{\circ}\text{C} - 40^{\circ}\text{C}$ → 3	INFO   →   ✓  ✗

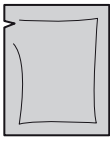

3	 1	$< 20^{\circ}\text{C}$ → 2 $20^{\circ}\text{C} - 40^{\circ}\text{C}$ → 4	 2
	 3	$20^{\circ}\text{C} - 40^{\circ}\text{C}$ → 4	INFO   →   ✓  ✗

1 

2  5

Adhesion Promoter $\geq 1.5 \text{ min.}$
 $< 60 \text{ min.}$

4

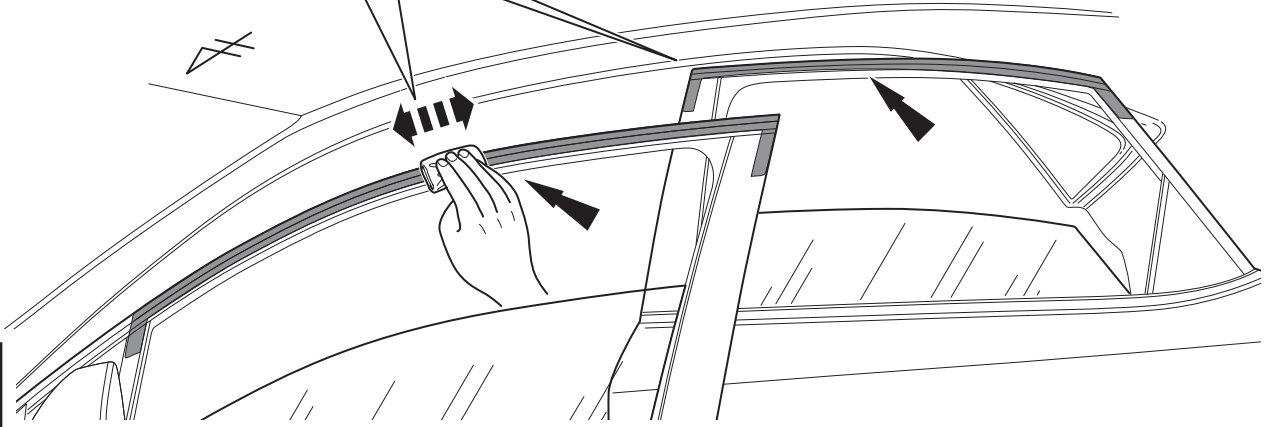

A

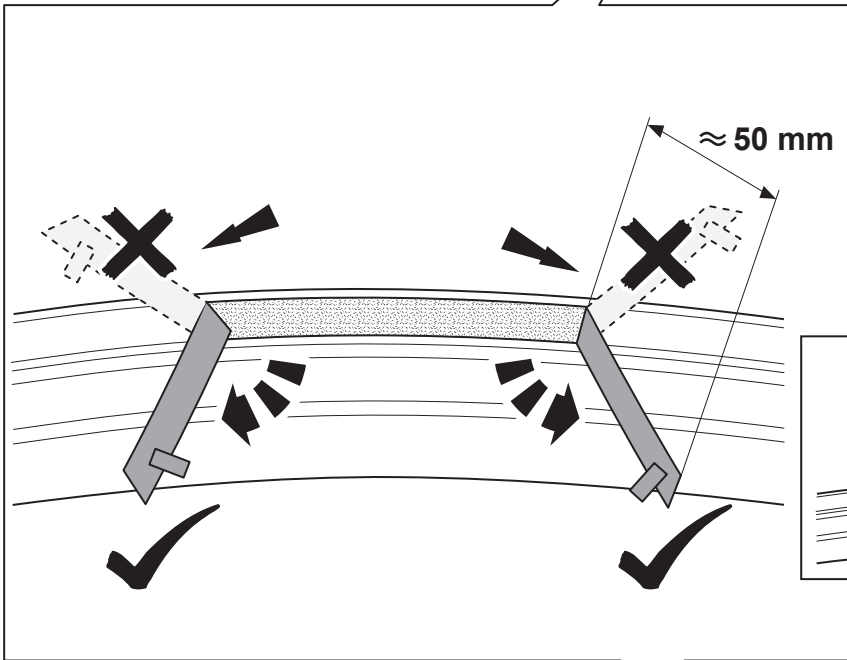
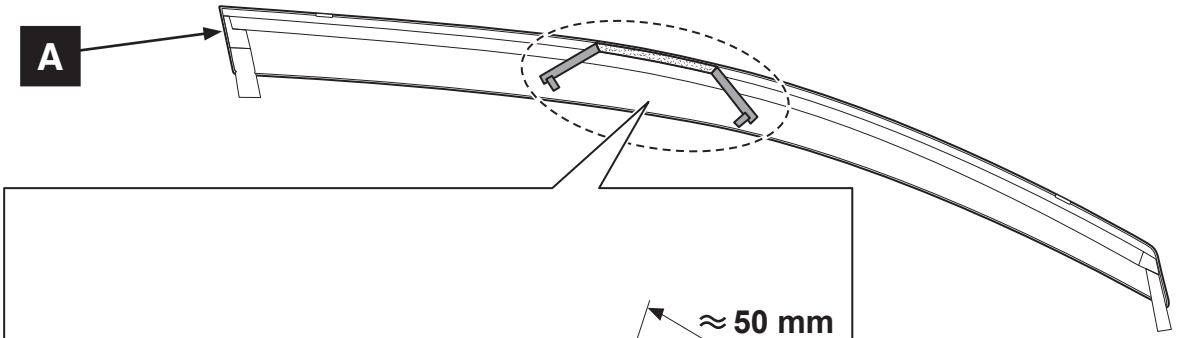

B

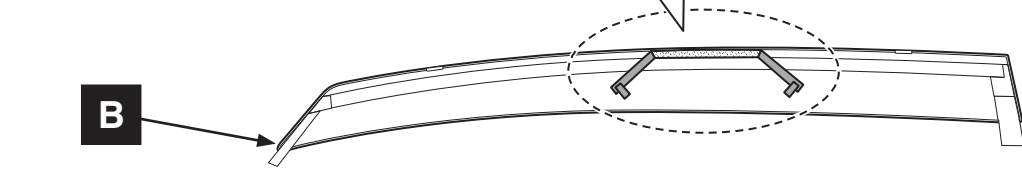

5

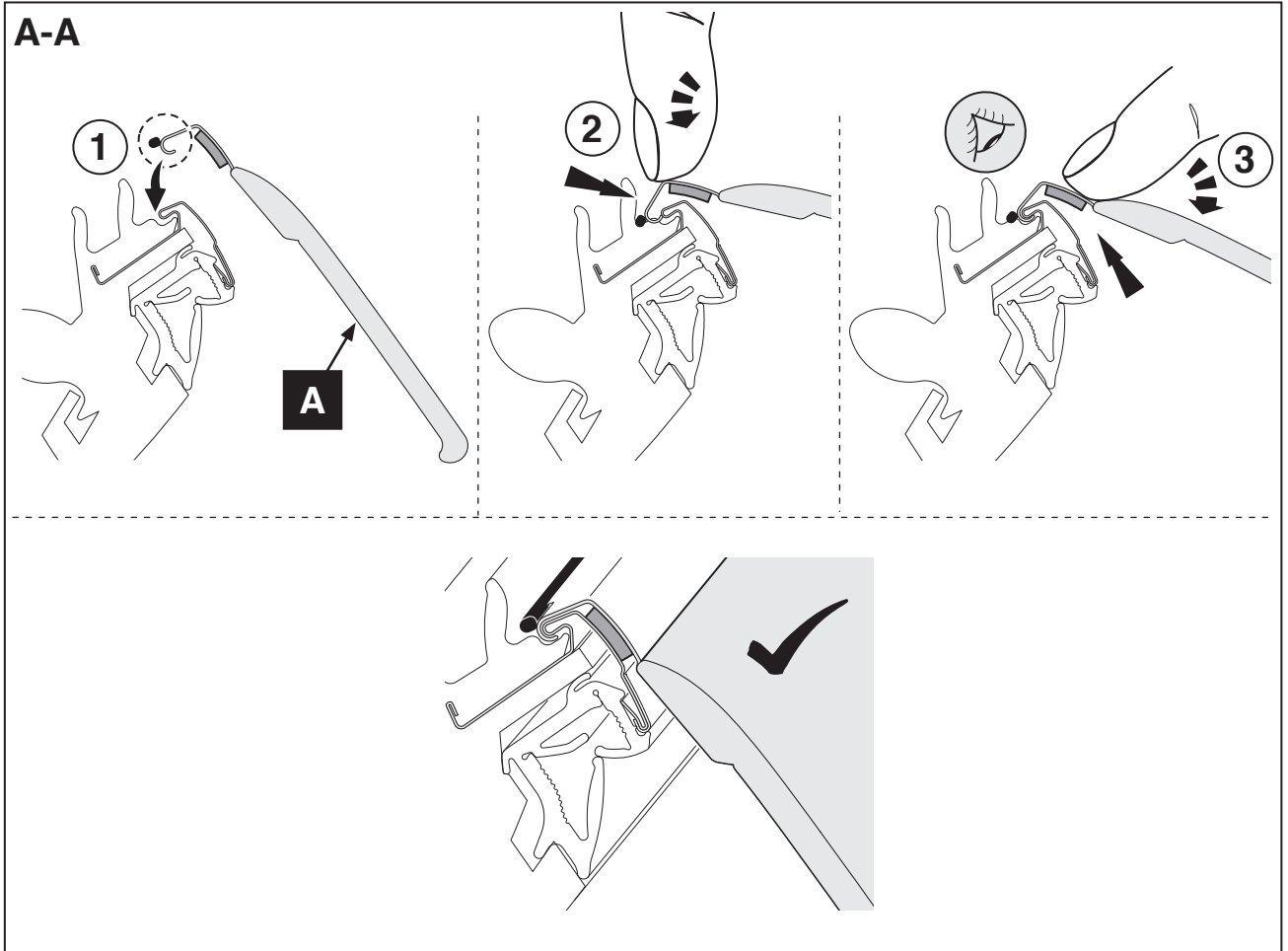
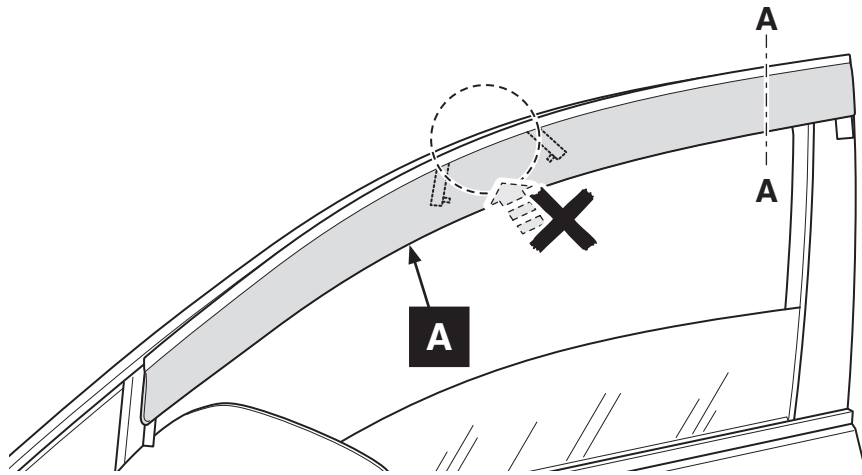

6

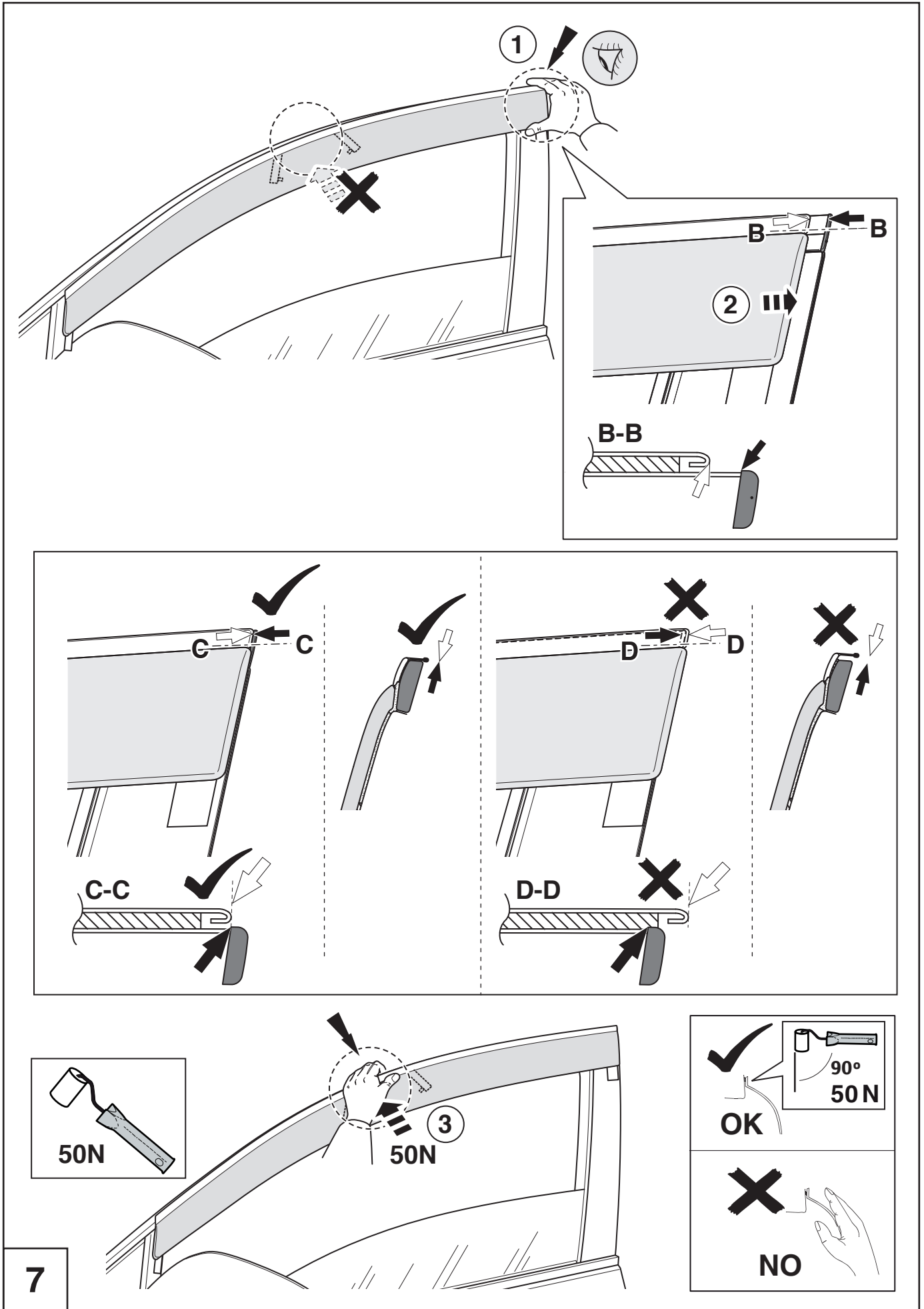

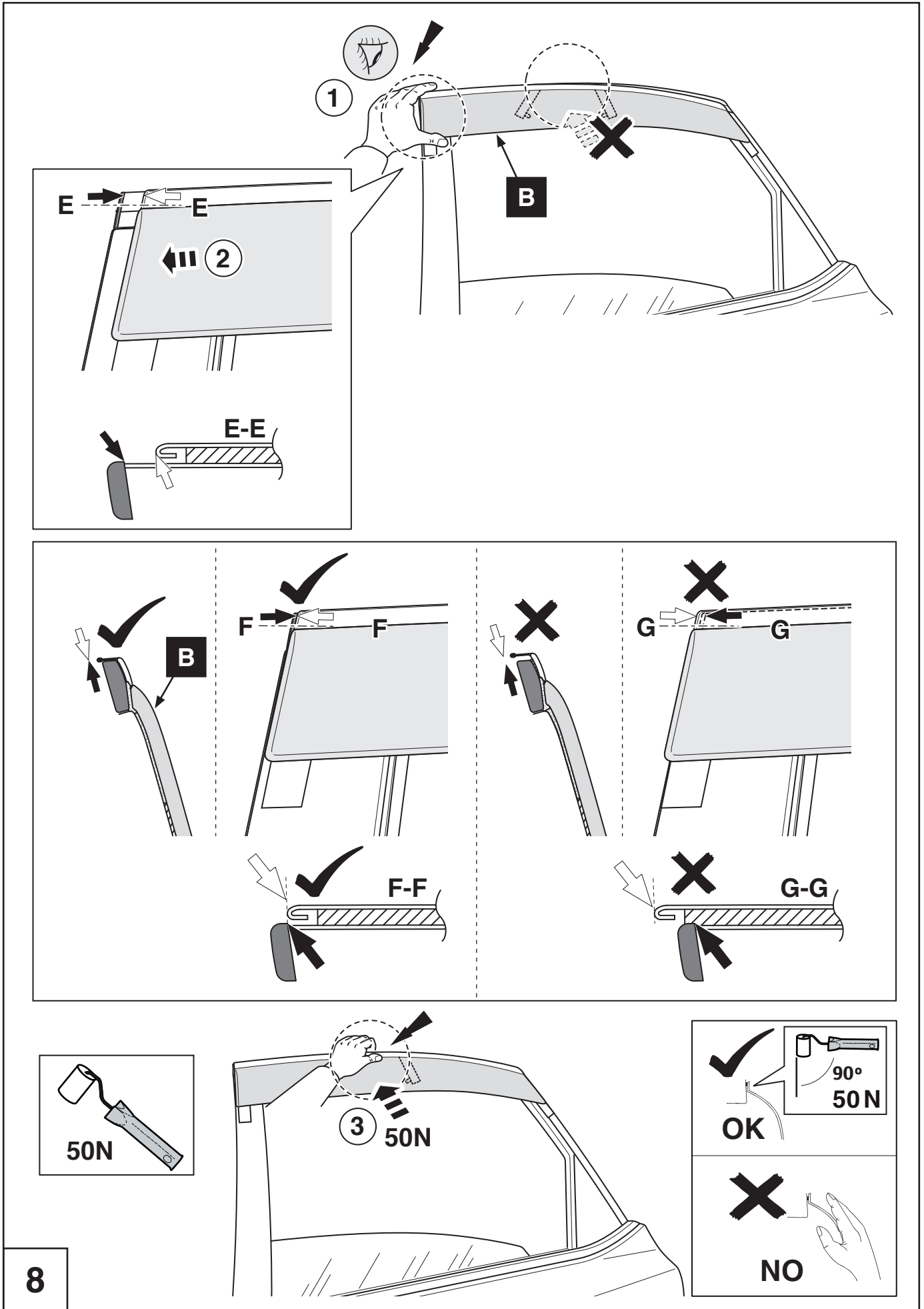

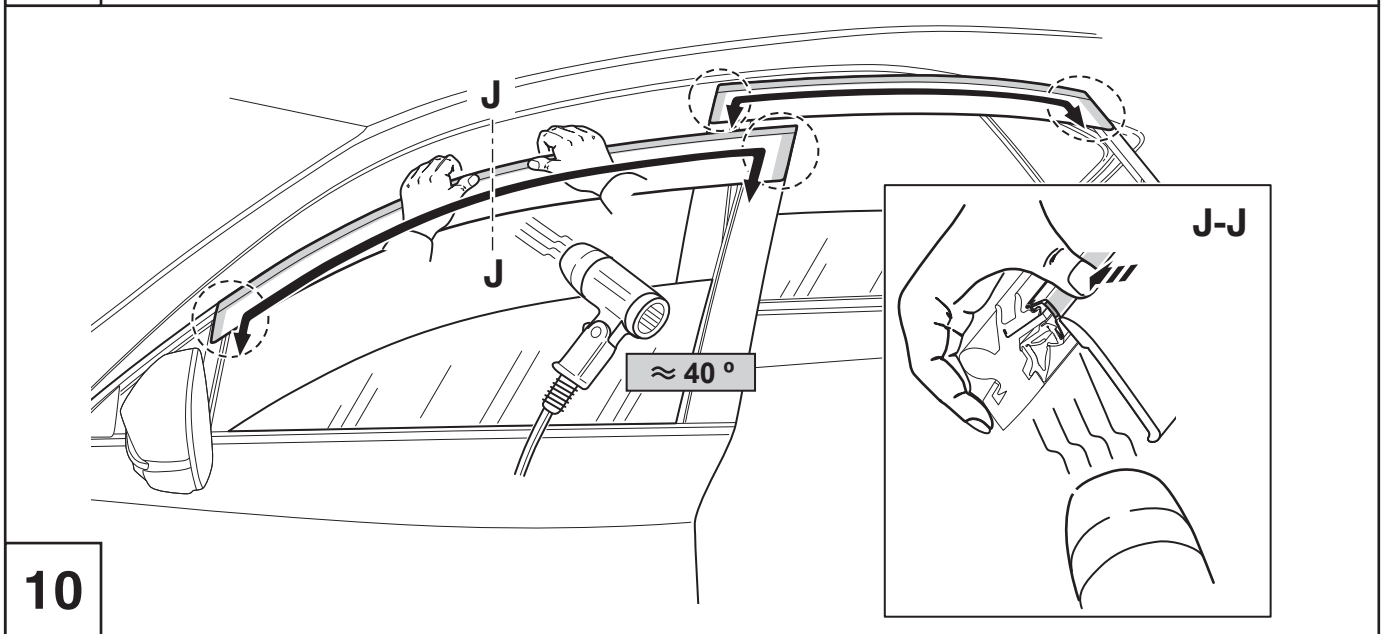
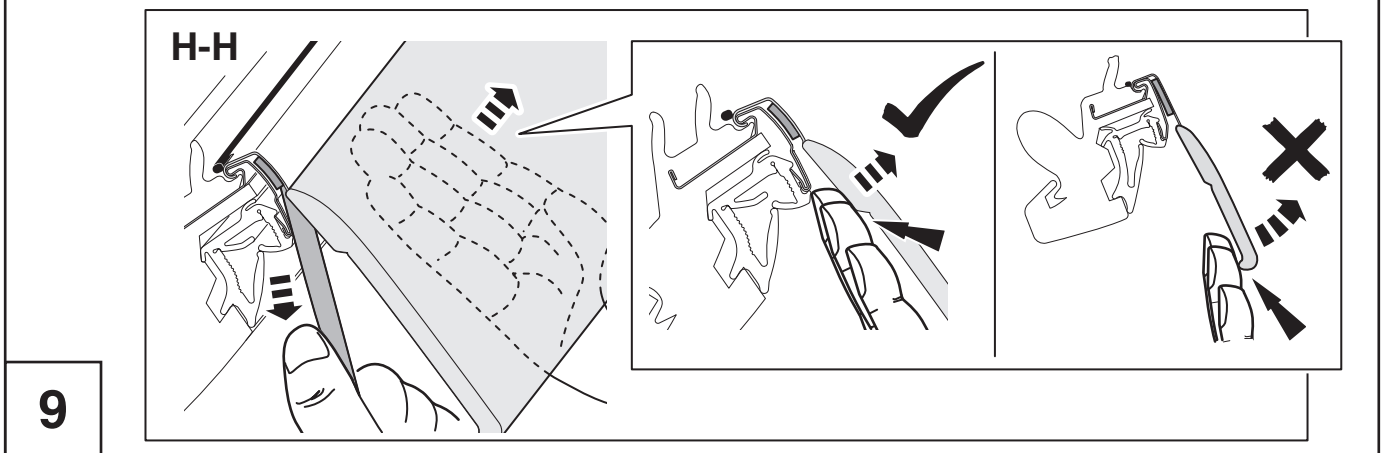
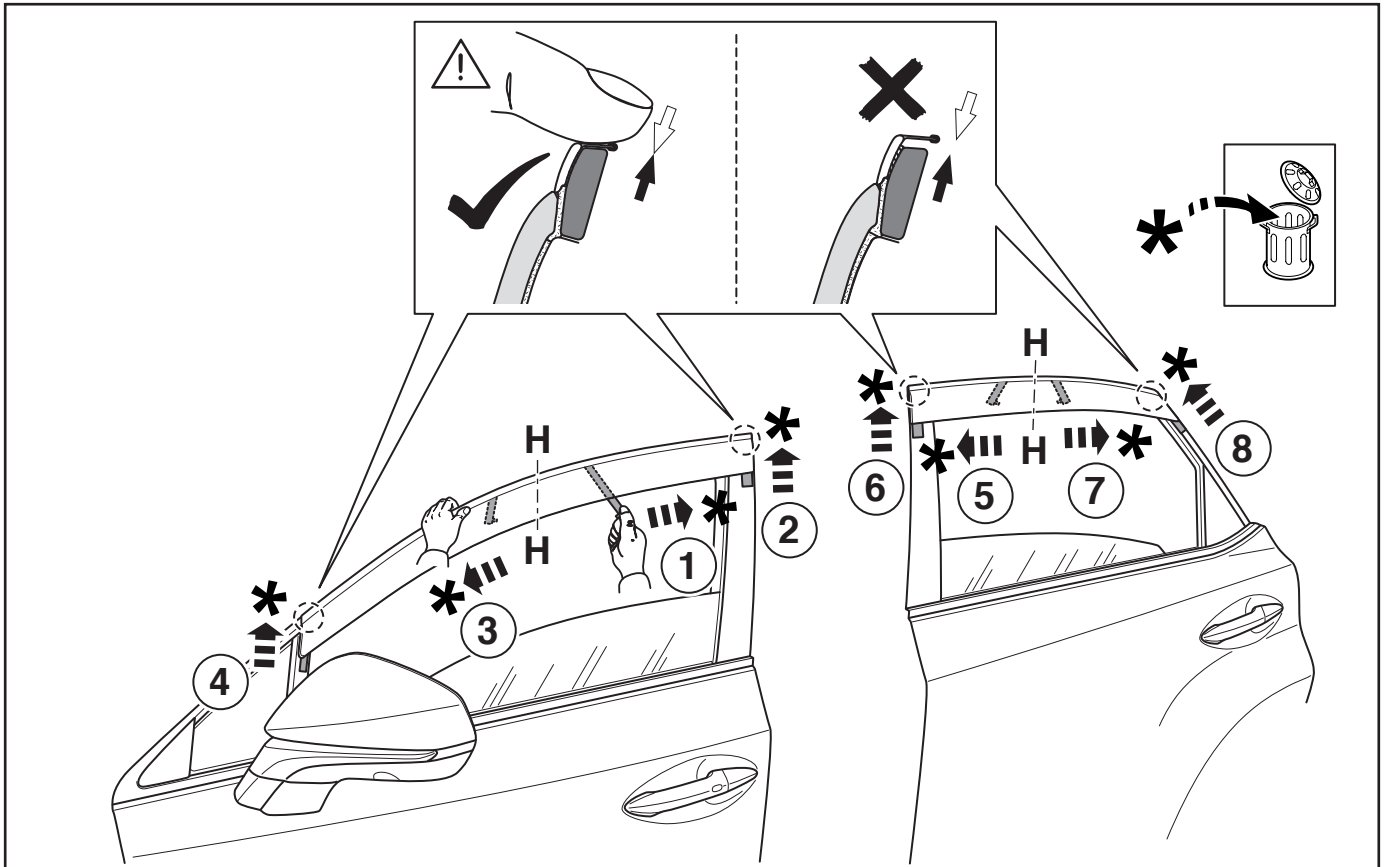

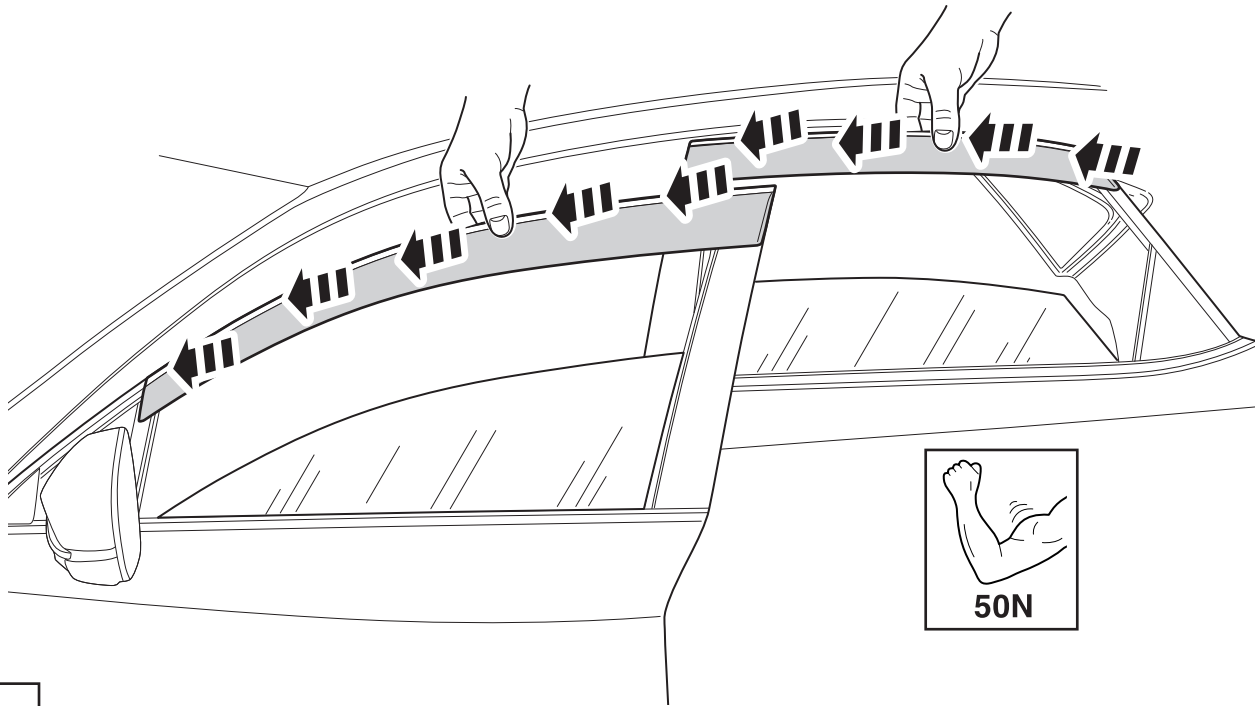

11

INFO

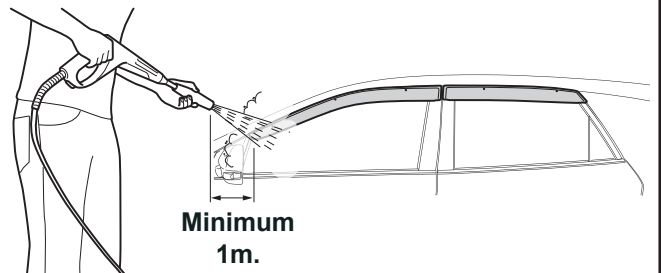
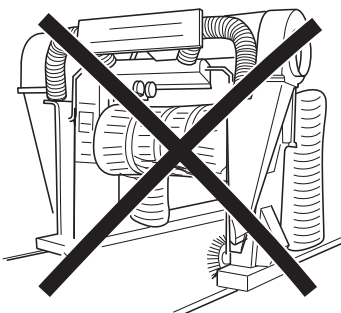
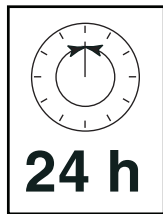
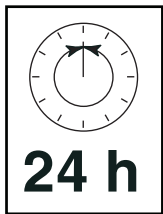
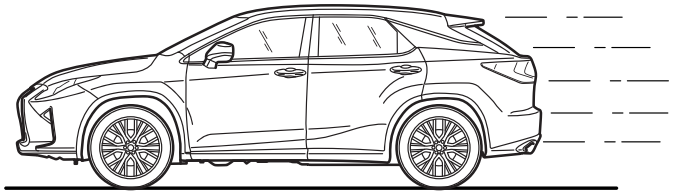
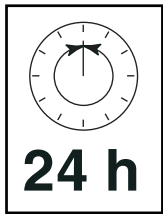

Model / Year

RX-L
As from 2017/12

Wind deflector

VIN n°

DURING INSTALLATION

P/N = OK

1

2

= OK

3

AFTER INSTALLATION

= OK

1

Installation Date:

.. / .. / ..

Technician Name & Signature:

Stamp: