





Mudflaps, Rear INSTALLATION INSTRUCTIONS IS





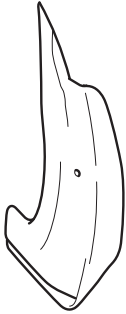





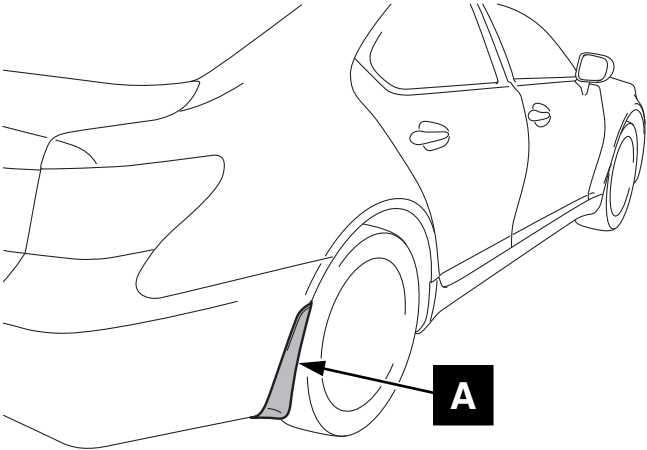

Model year	2013/04 - 2016/10
Vehicle code	**E30*-AE**HW
Part number	PZ416 - C1967-00

Revision Record

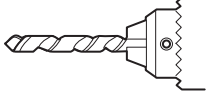
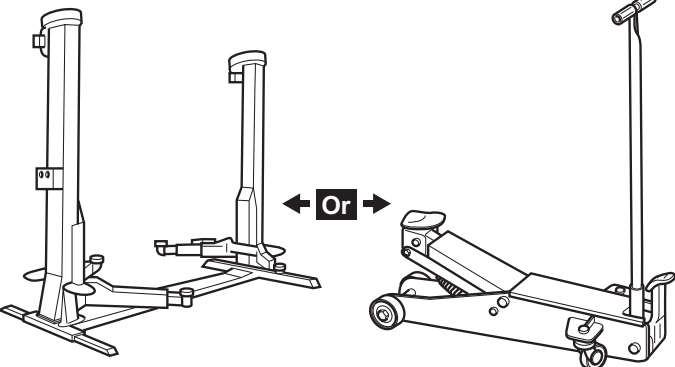
Rev. No.	Date	Page	Picture	Update	New	Deleted
1	26.08.14	2		X		
2	29.11.16	1-7	3, 4, 10, 13	X		

PZ416 - C1967-00

A	B	C	D	E
				
1x	1x	2x	2x	2x

	 ph2 			
				
		 Ø 3mm		
				 10mm 21mm
				 CLEANER / DEGREASER

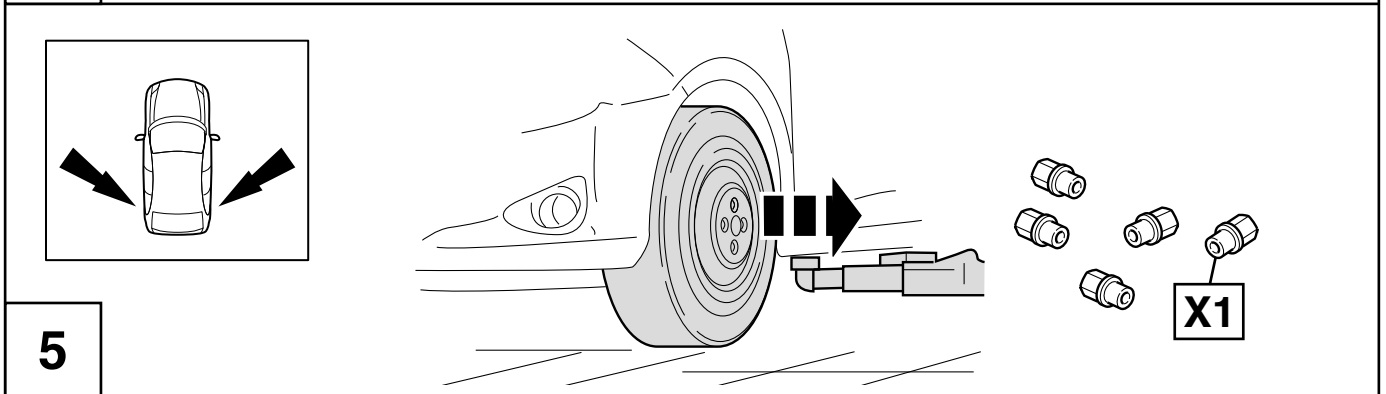
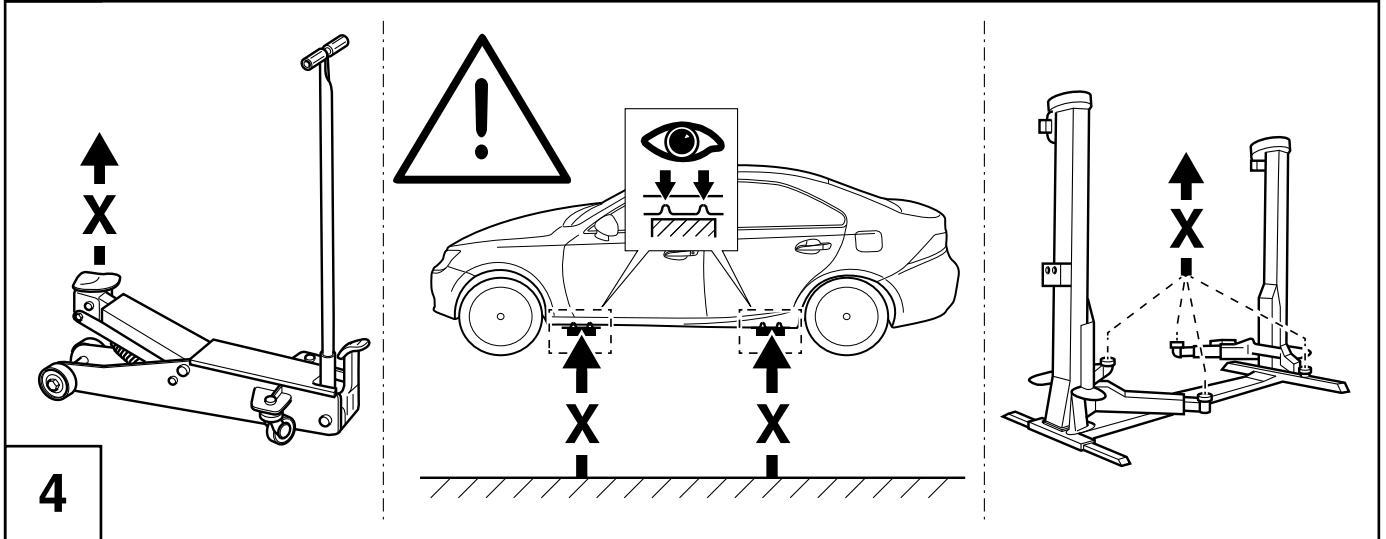
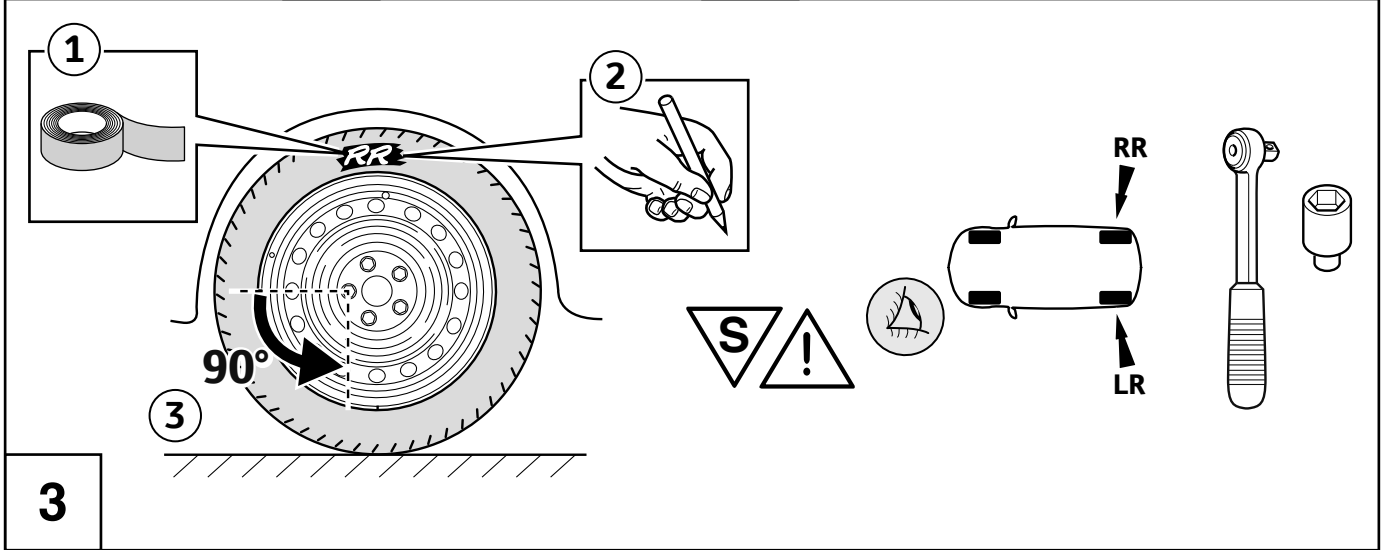
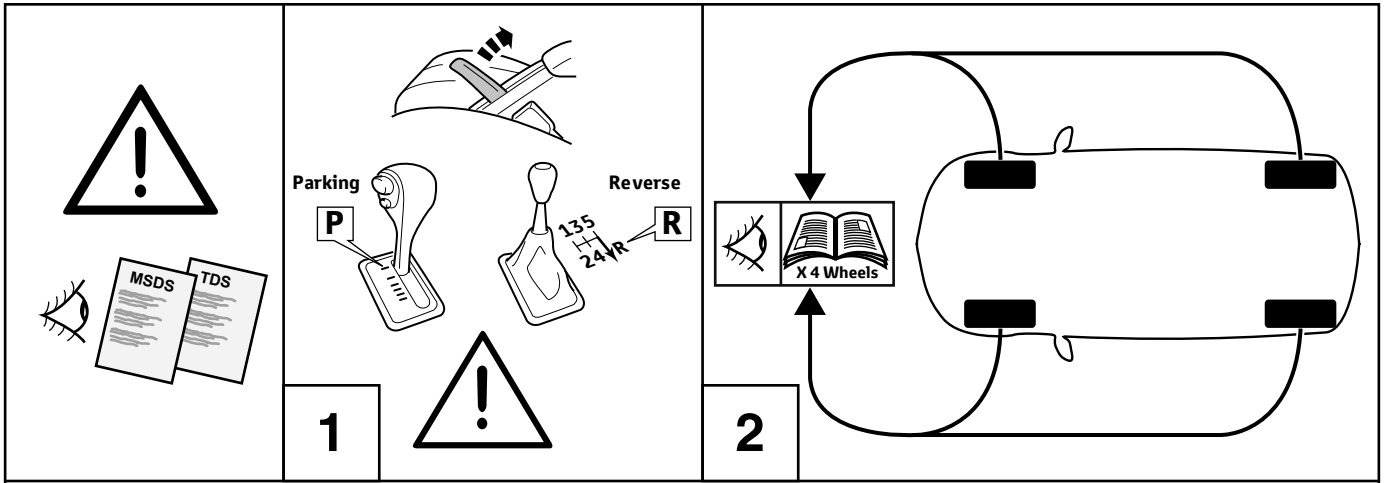

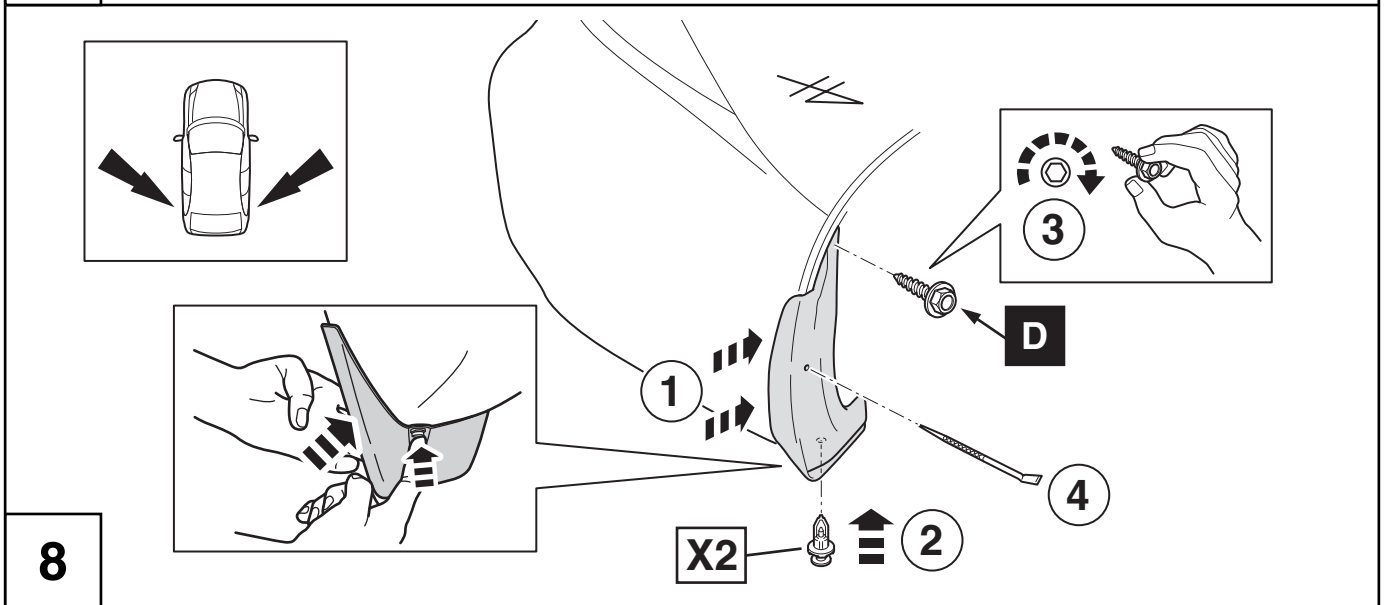
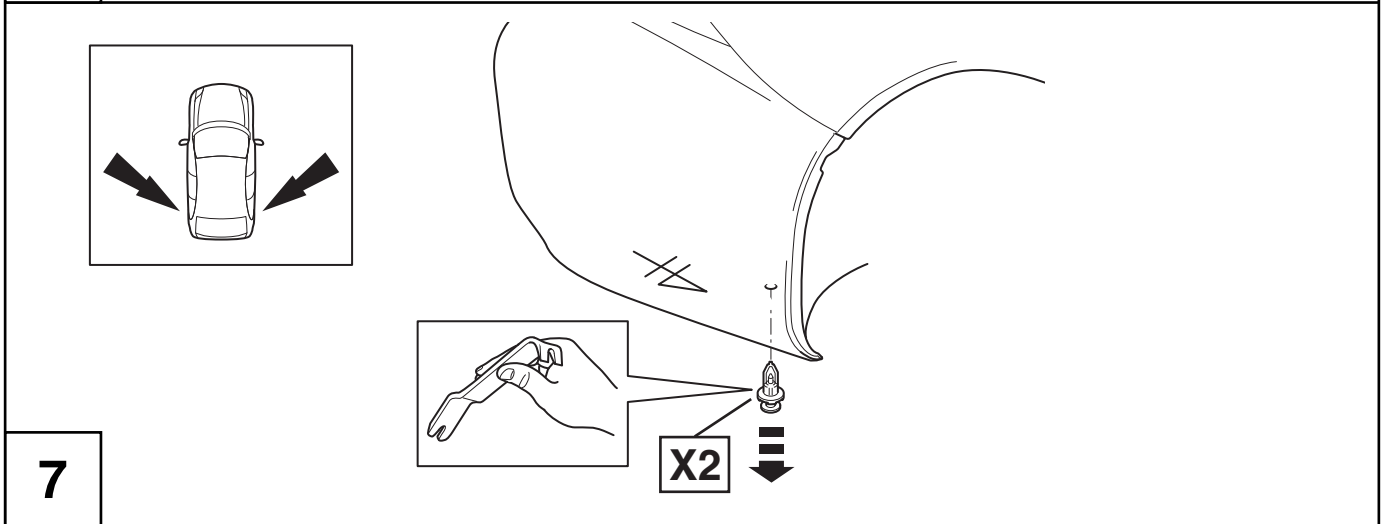
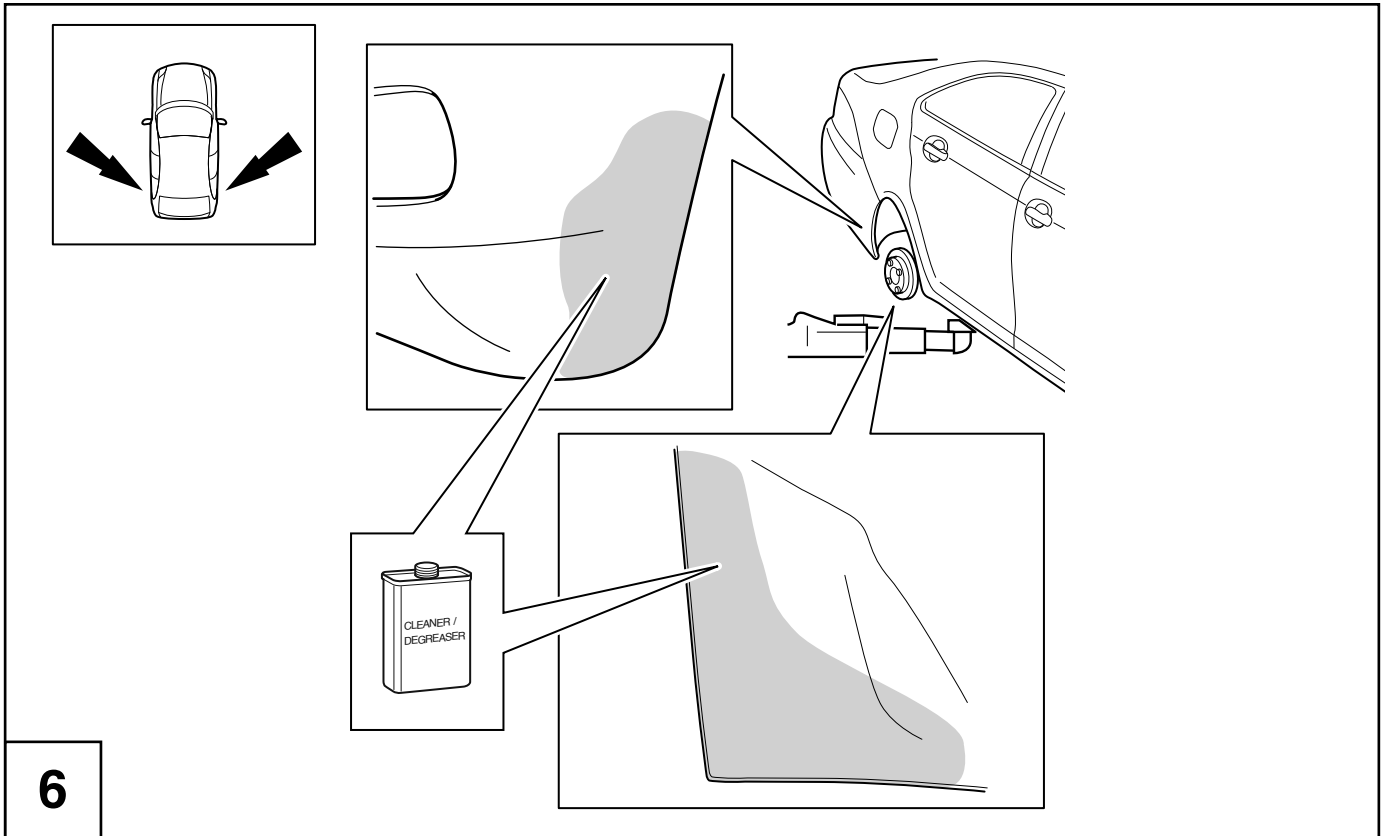

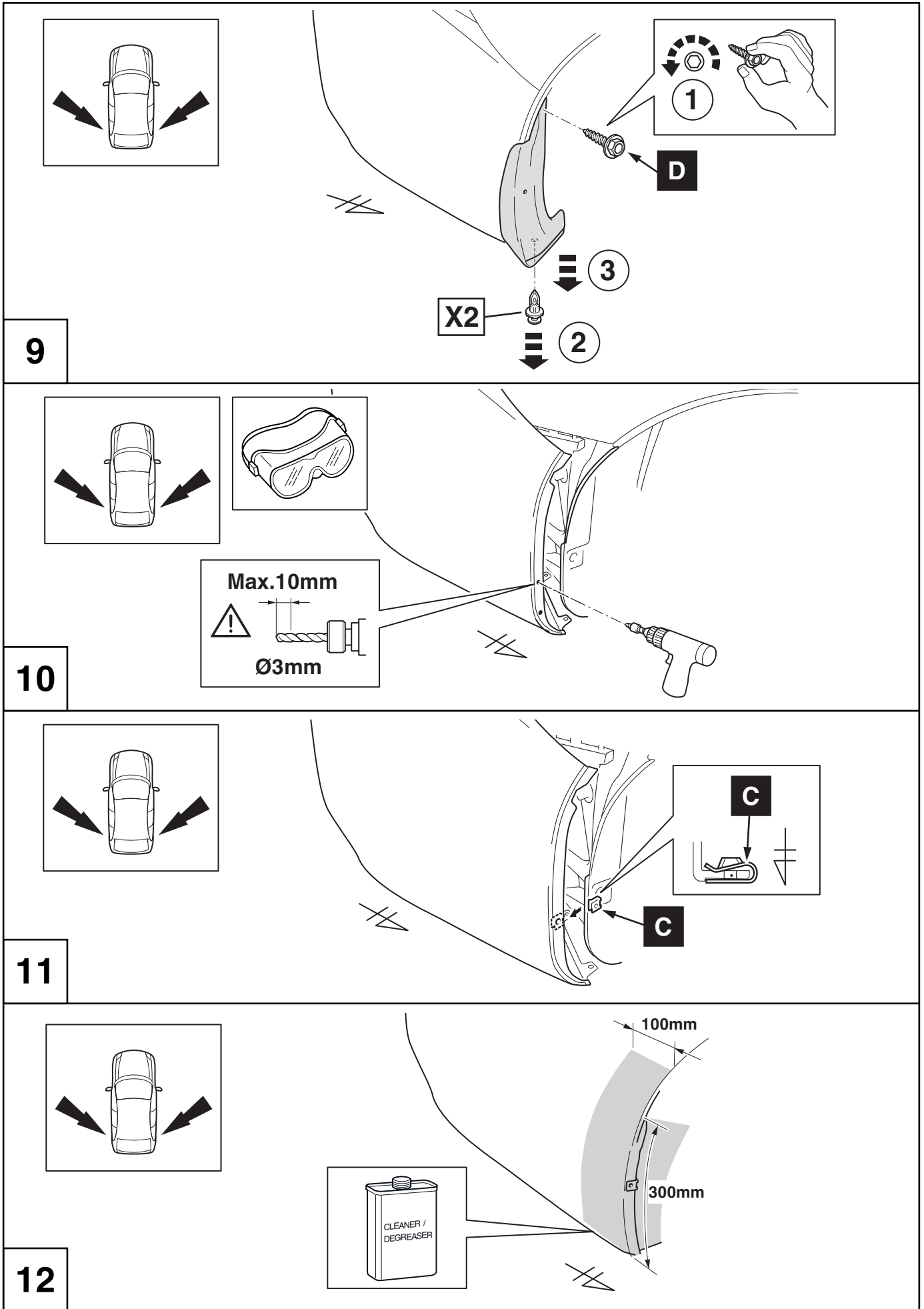

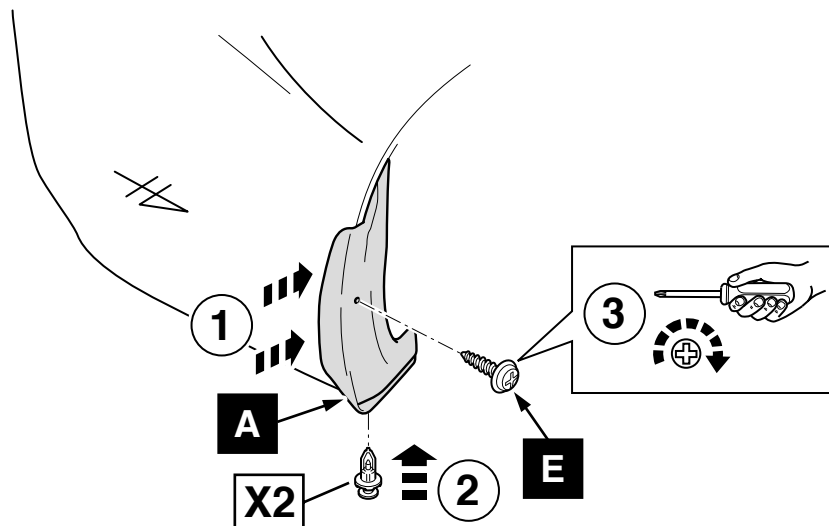
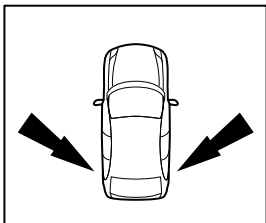

13

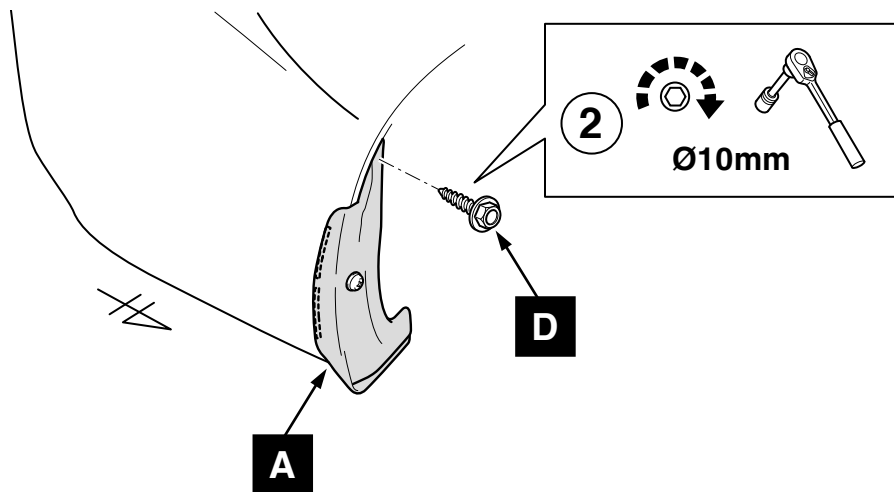
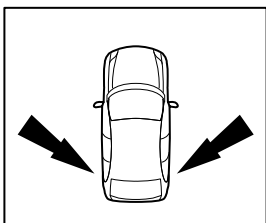

14

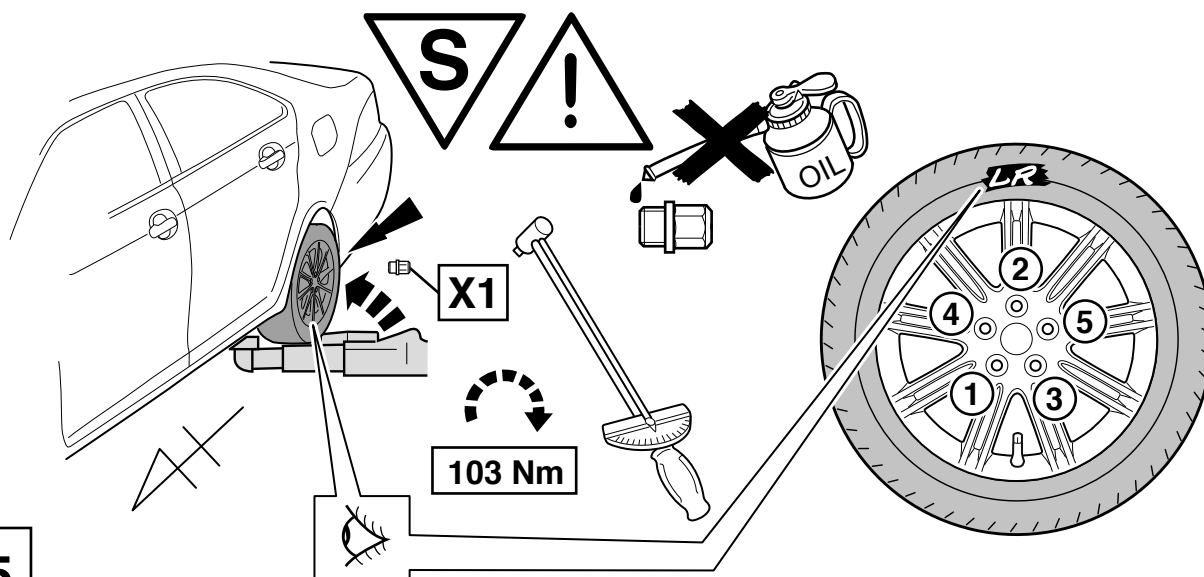

15

CHECK SHEET



Model / Year **LEXUS IS**
2013/04 - 2016/10

Mudflaps , Rear

VIN n°

P/N = OK



=A



=B

103 Nm

Serial Number

=A =B

RR = RR

LR = LR

= OK

Installation Date:

.. / .. / ..

Technician Name & Signature:

Stamp:

