

Sport Badge INSTALLATION INSTRUCTIONS GX

Model year	2013/08
Vehicle code	*RJ15*L - GK**K*
Part number	PW189-60001

Revision Record

Rev. No.	Date	Page	Picture	Update	New	Deleted

PW189-60001



A

2x

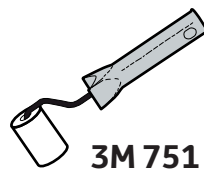
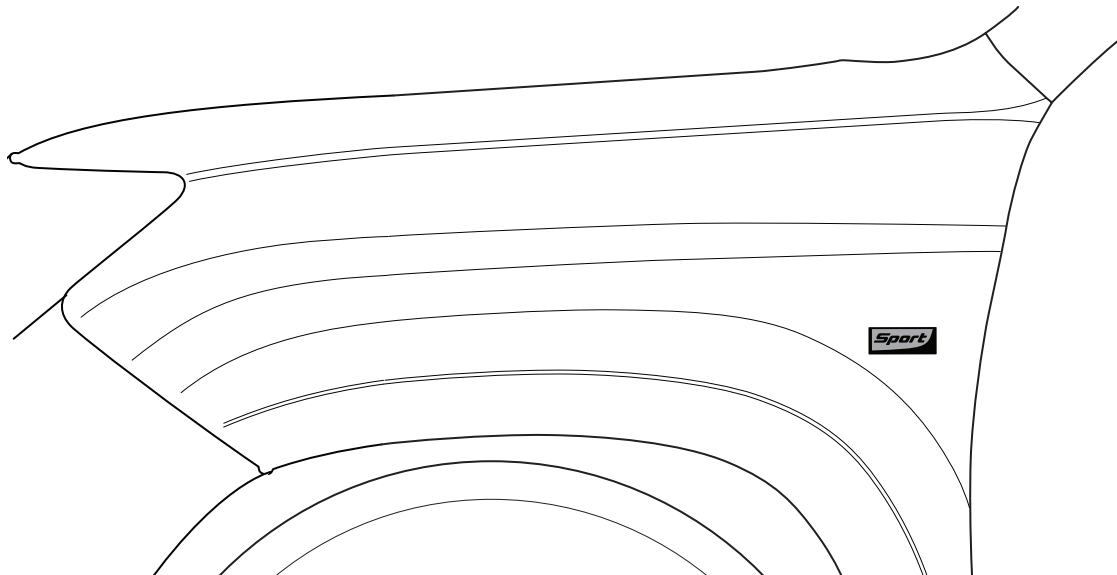

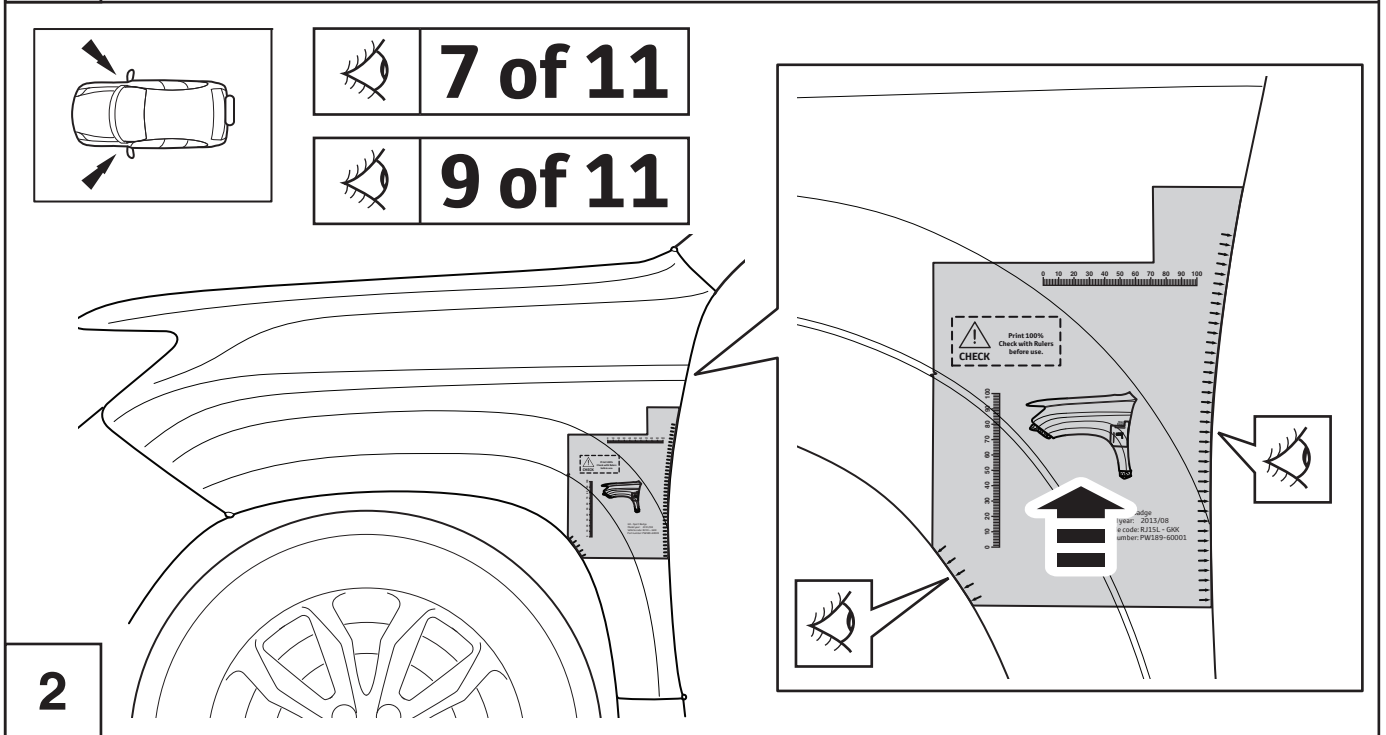
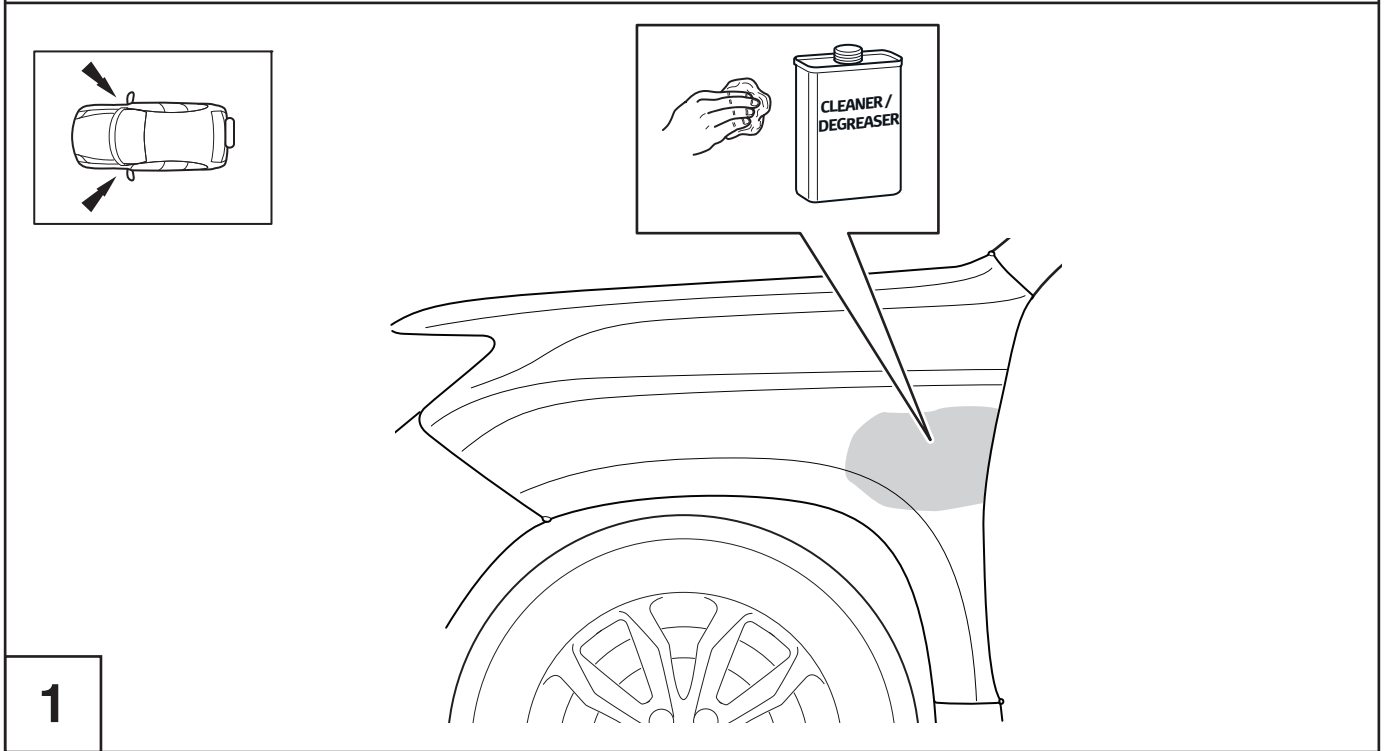
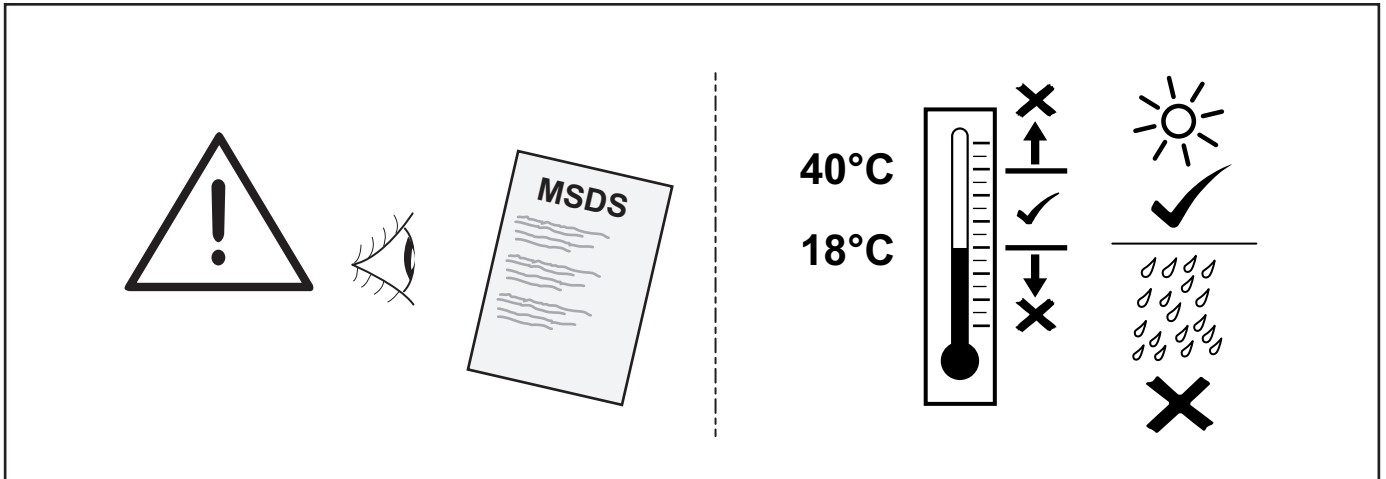

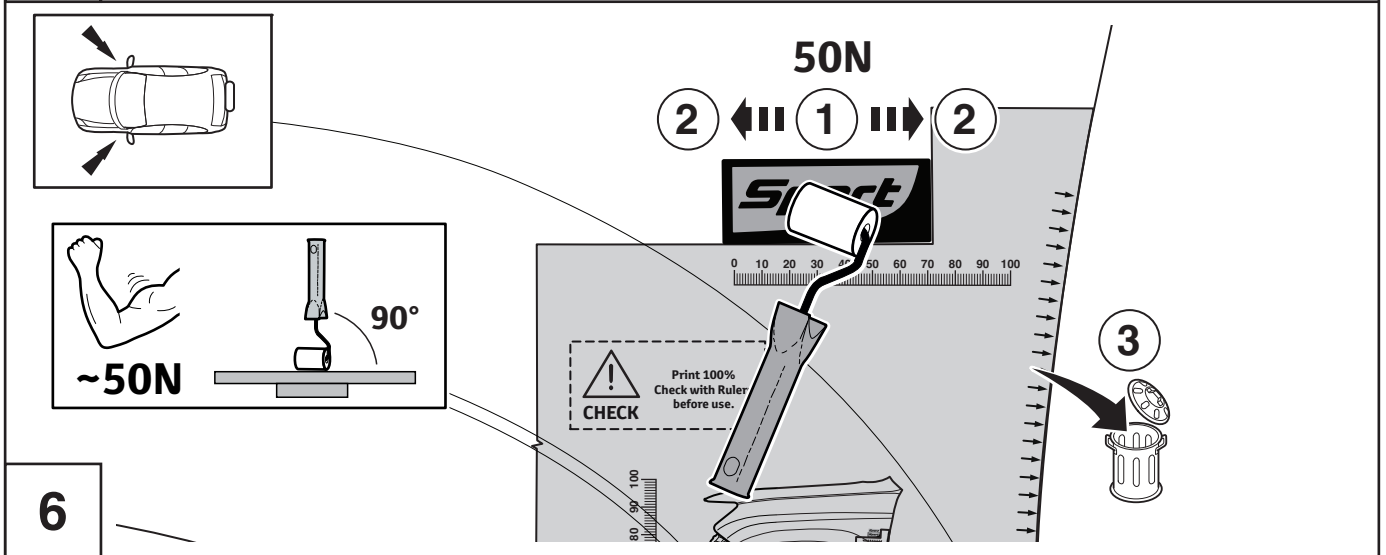
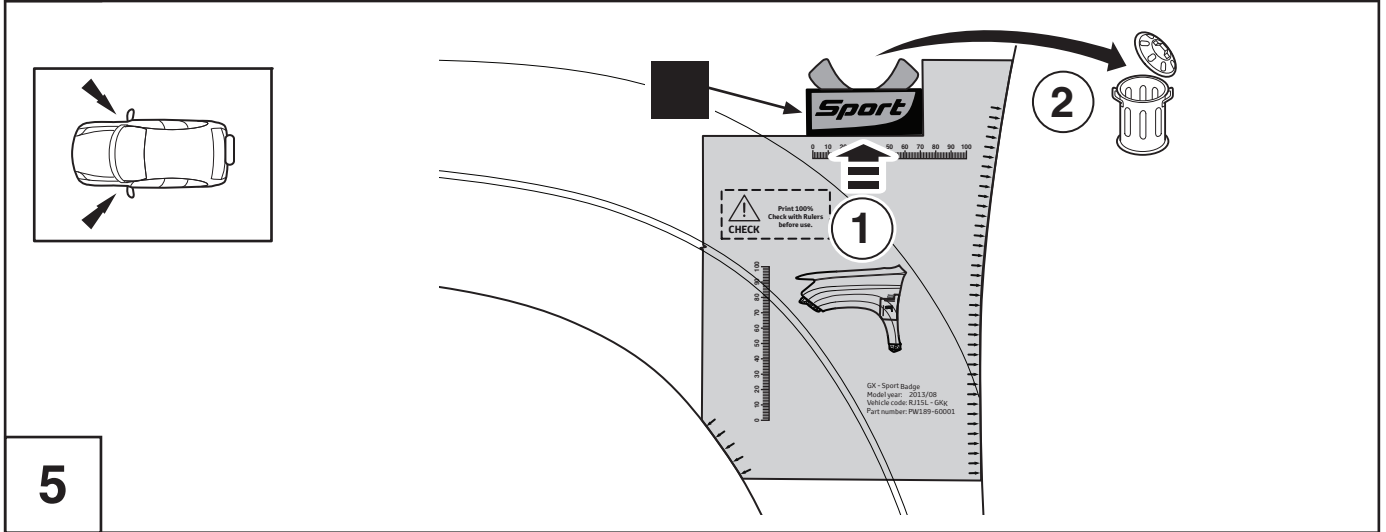
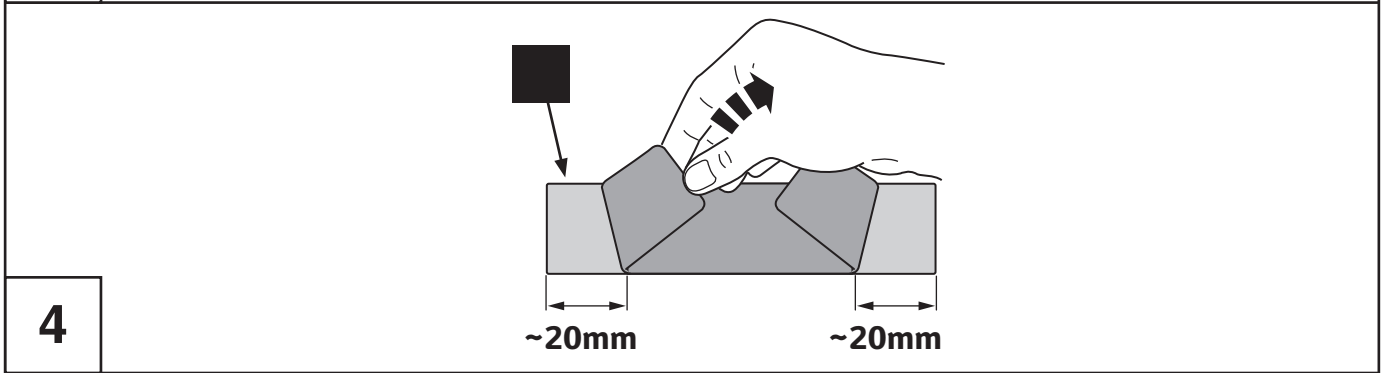
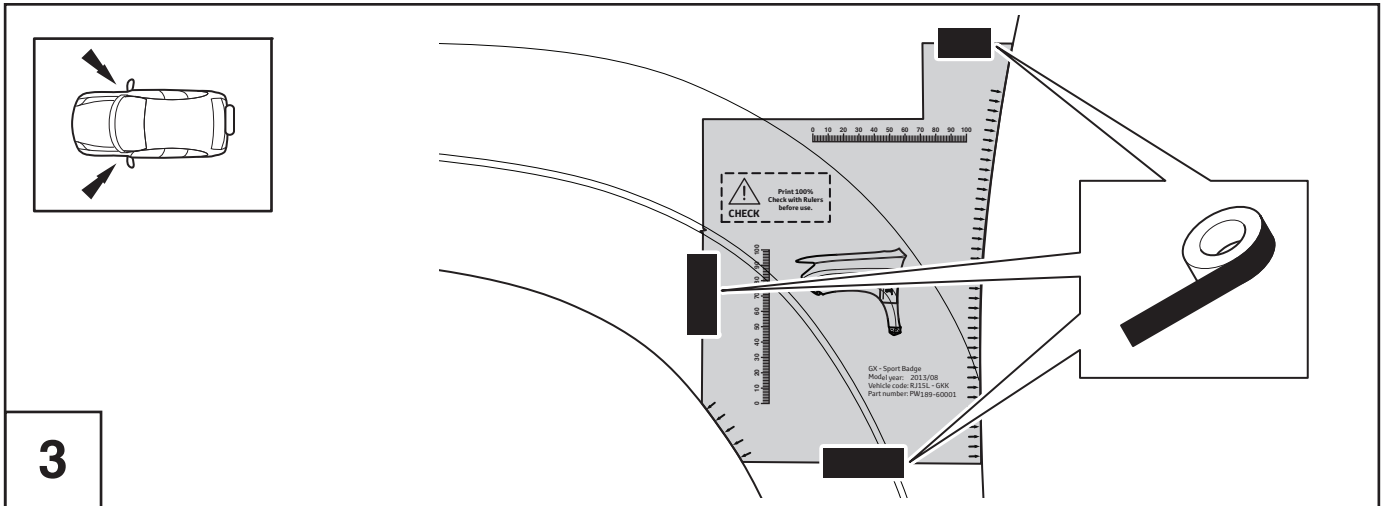

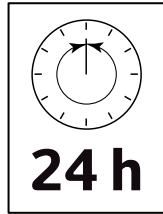
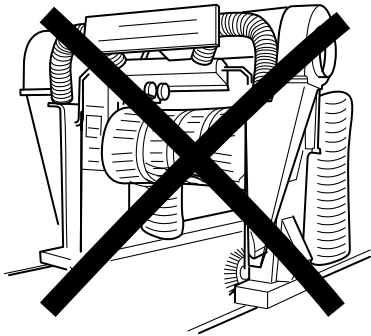
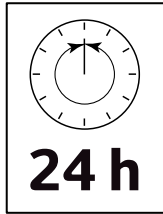

> 1 meter

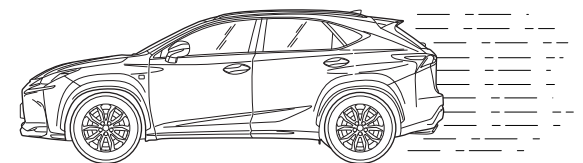
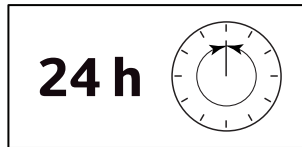
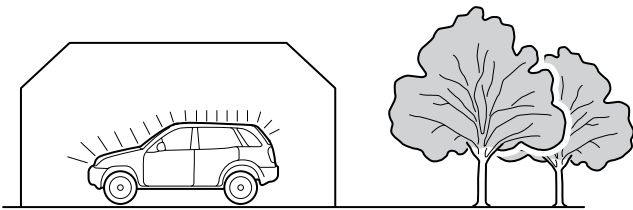
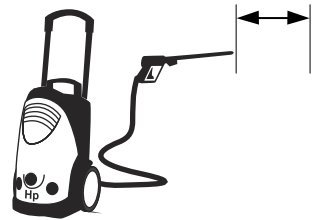

Max. 90 Km/h



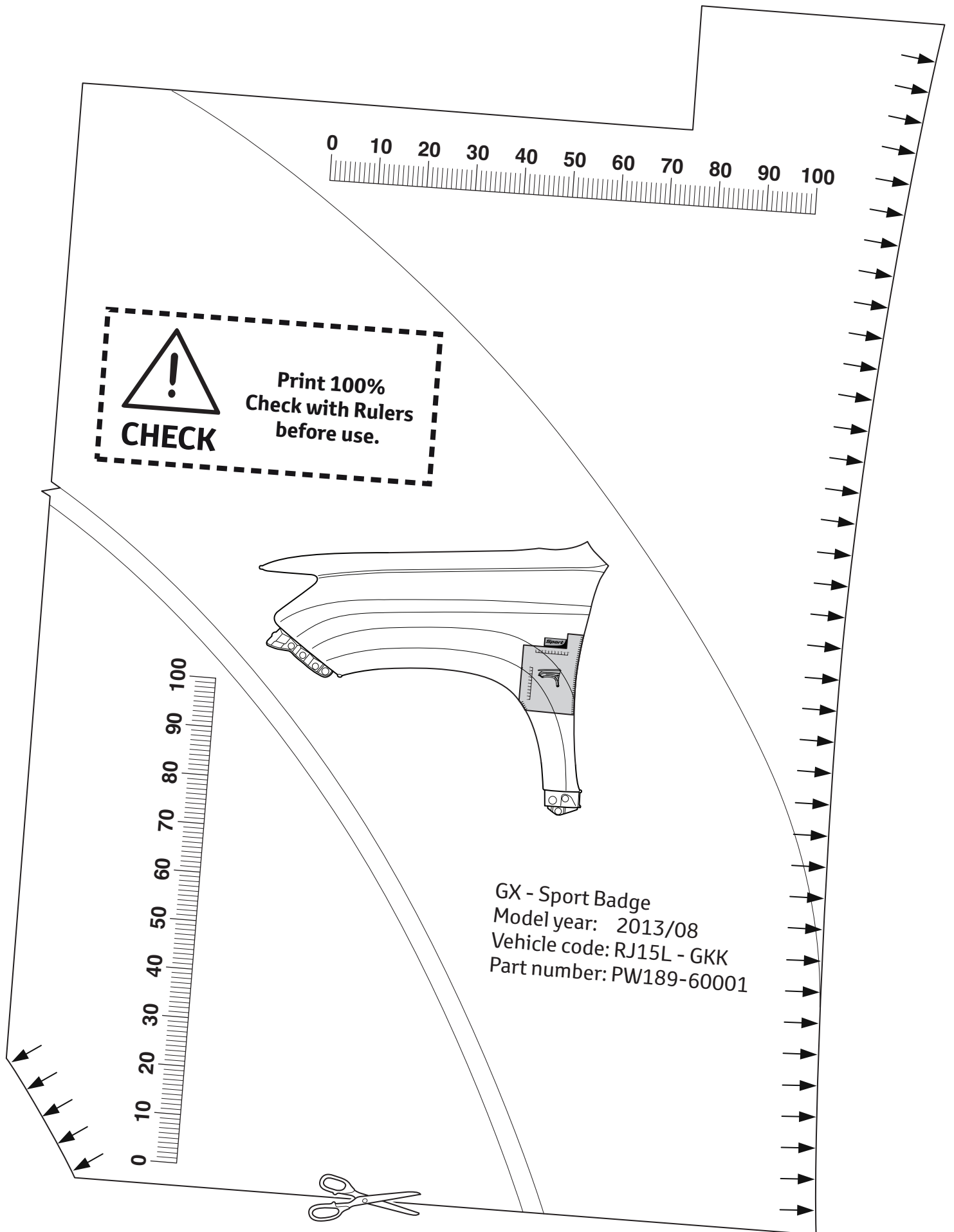



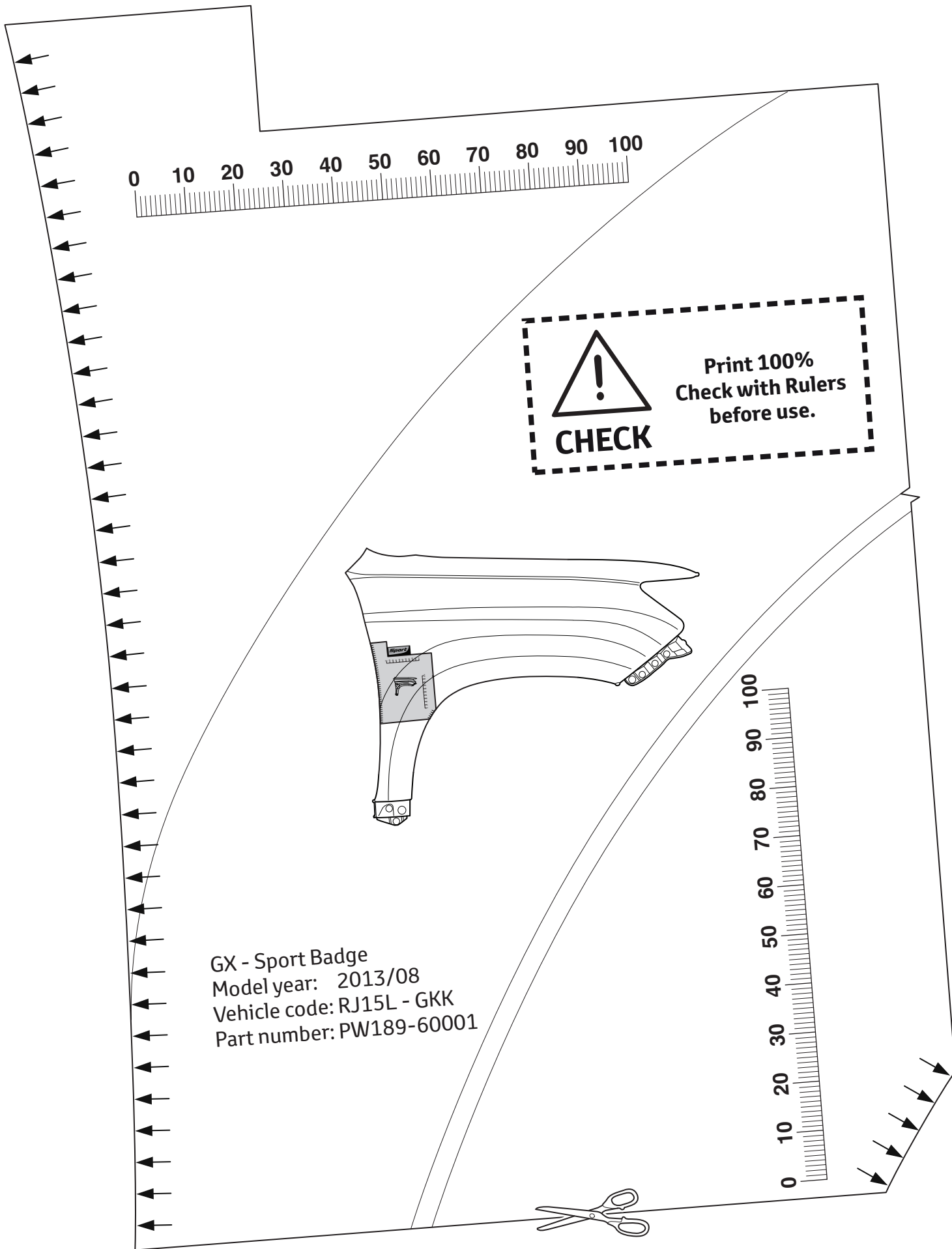



CHECK SHEET



Model / Year **GX 2013/08**



GX
Sport Badge

VIN n°

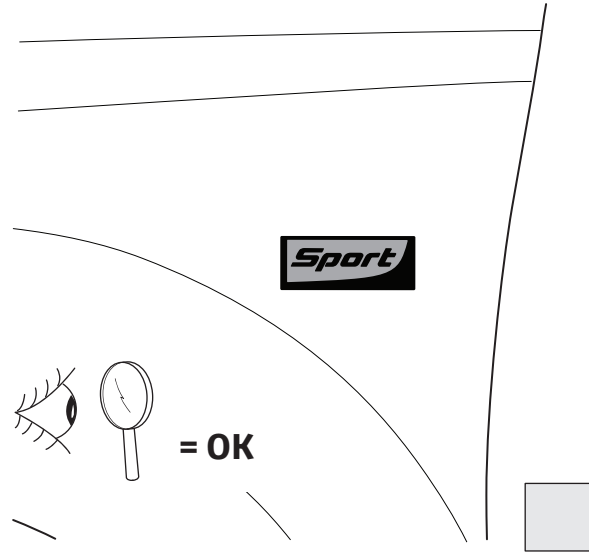
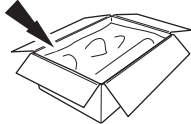
 **P/N = OK**





Sport

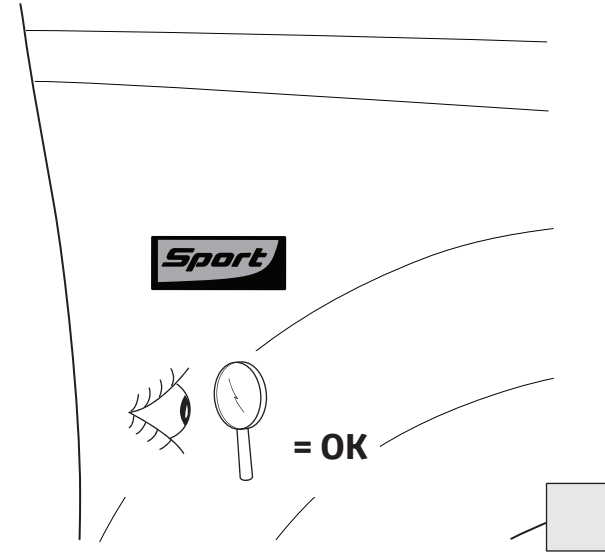

  = OK





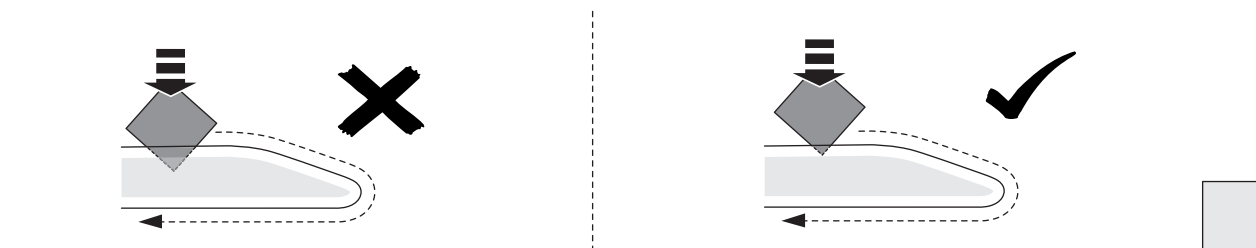

Sport

  = OK



  = OK

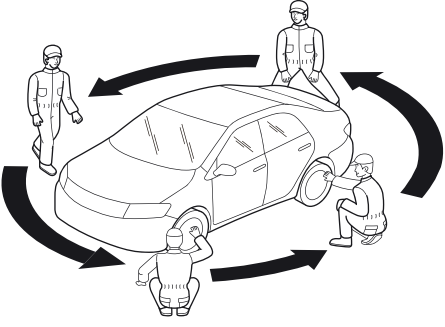

Installation Date:

. . / . . /

Technician Name & Signature:

Stamp:

