

Rear bumper protection plate INSTALLATION INSTRUCTIONS NX

Model year	2014/07, 2017/09
Vehicle code	**Z1**-AW***W
Part number	PZ467-X0541-ZA

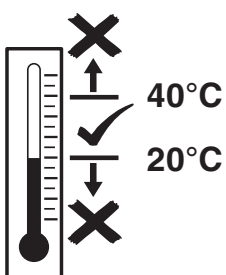

1

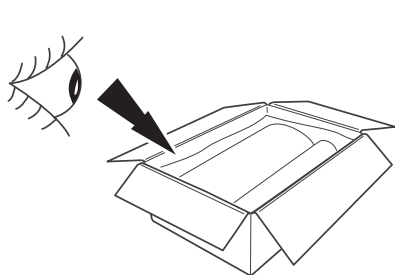
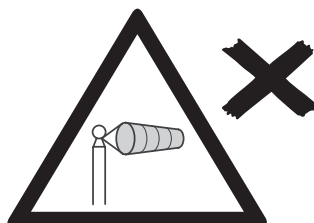
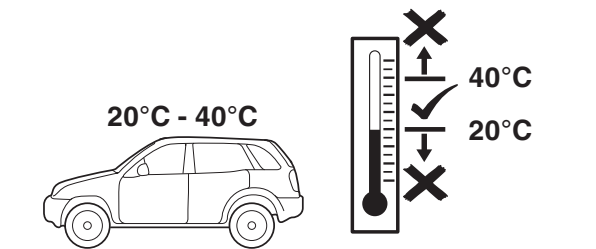
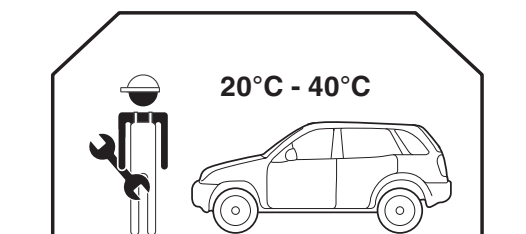
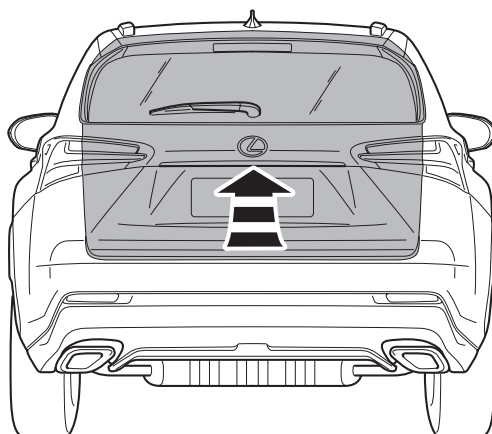

2

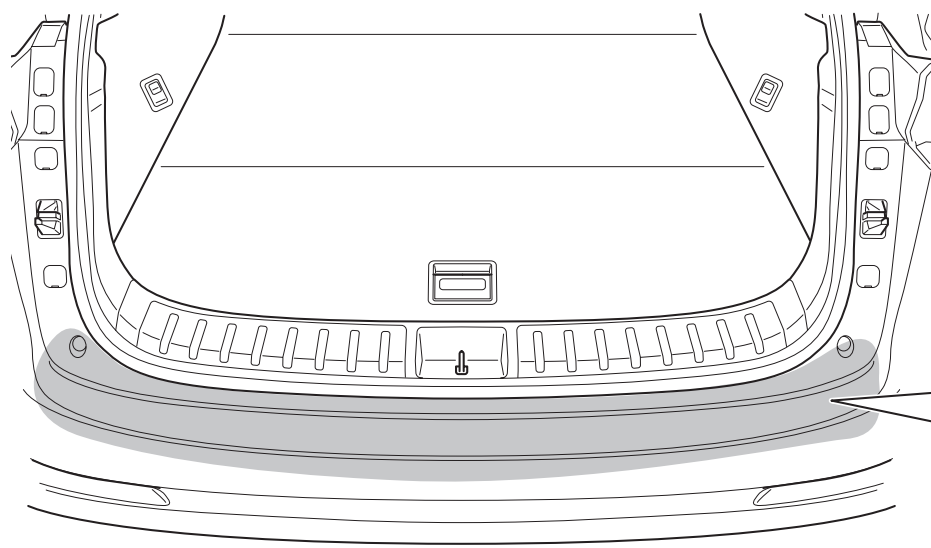

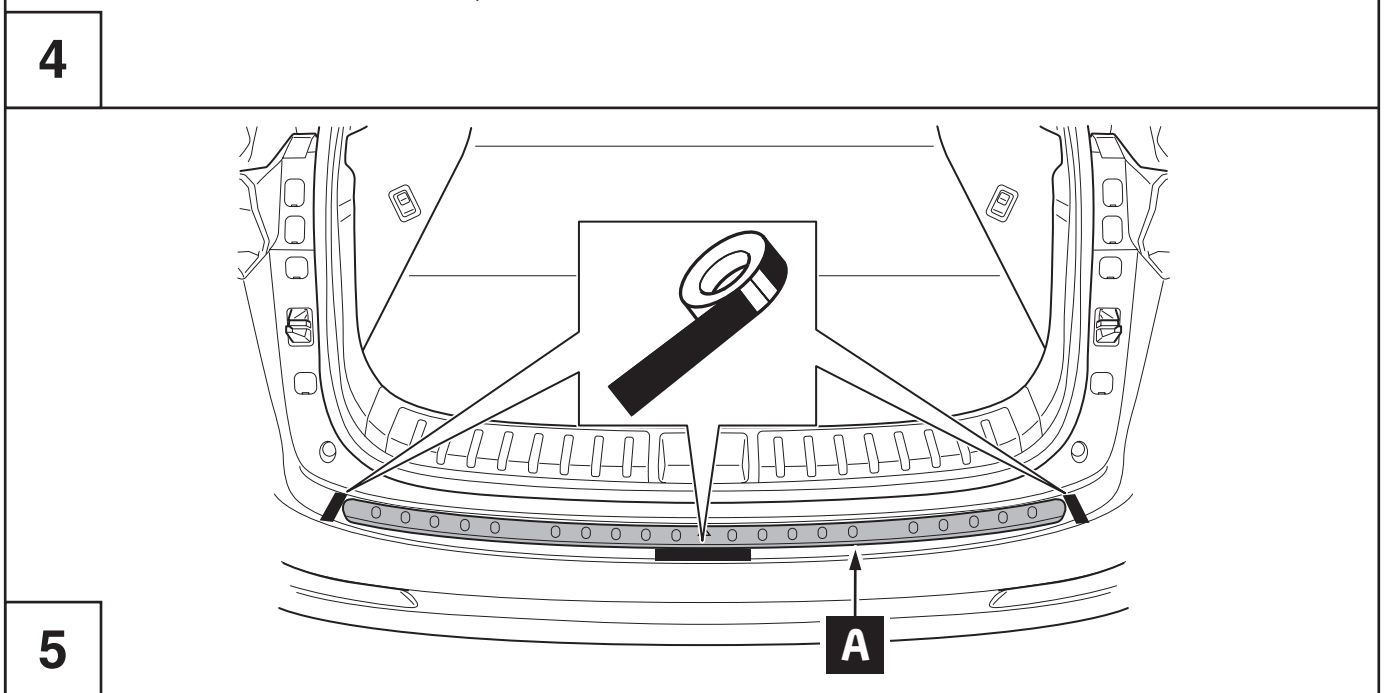
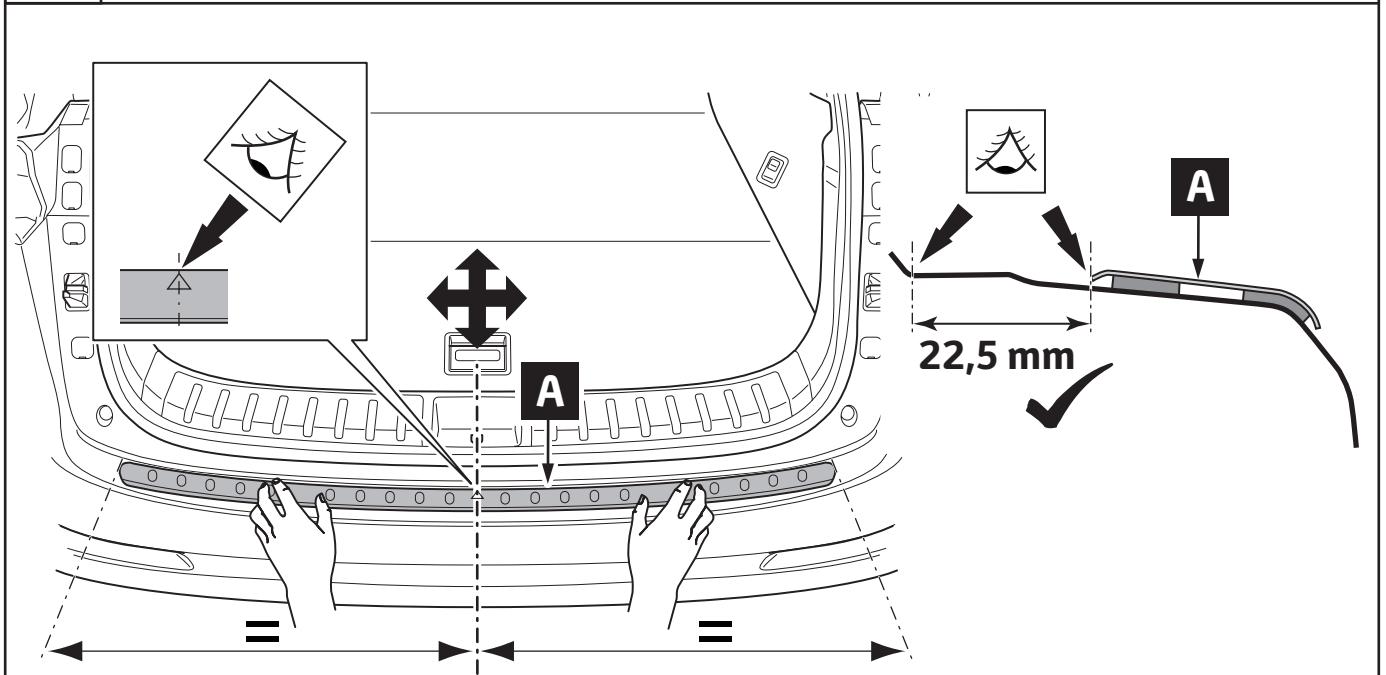
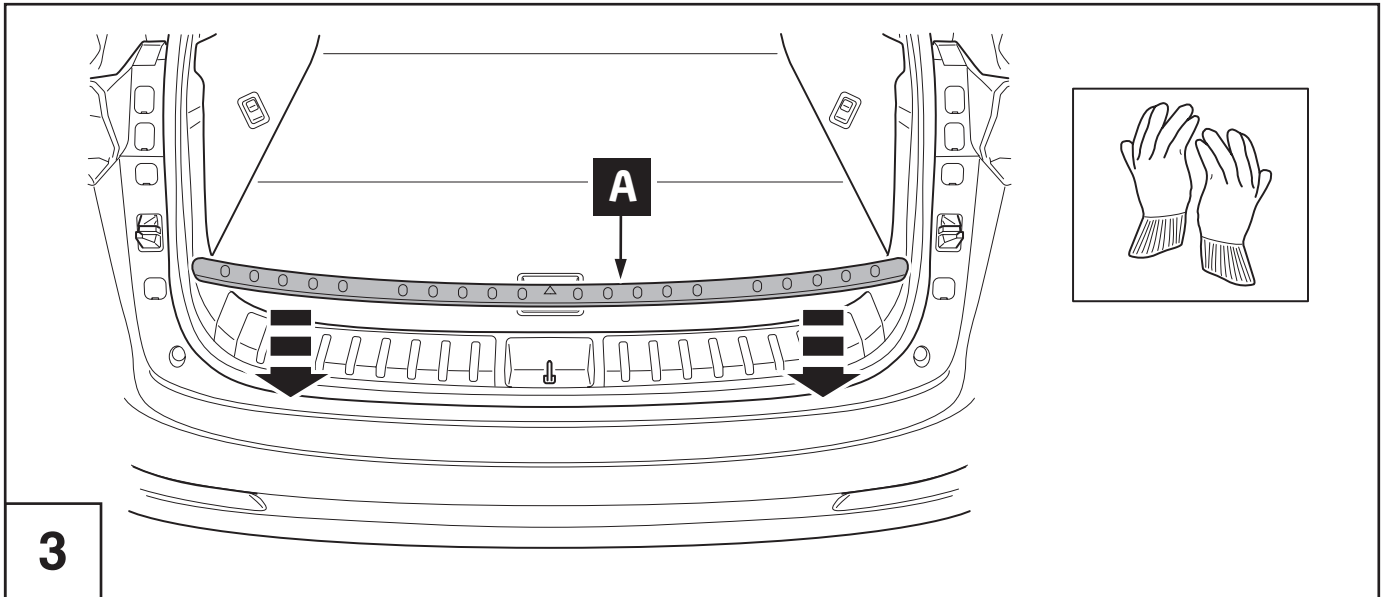

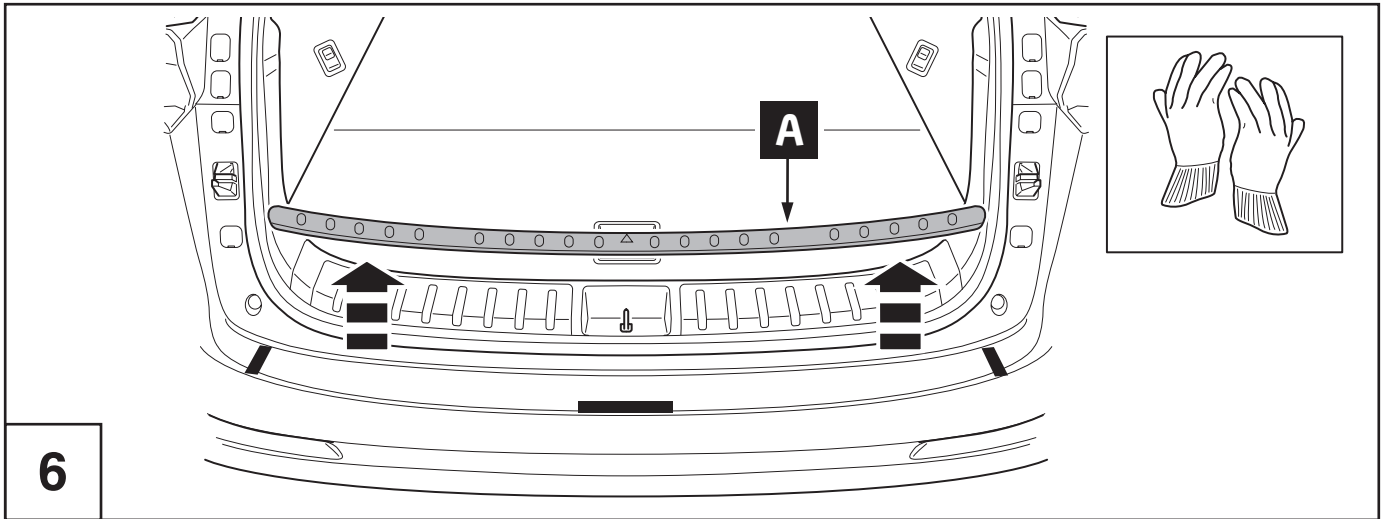

6

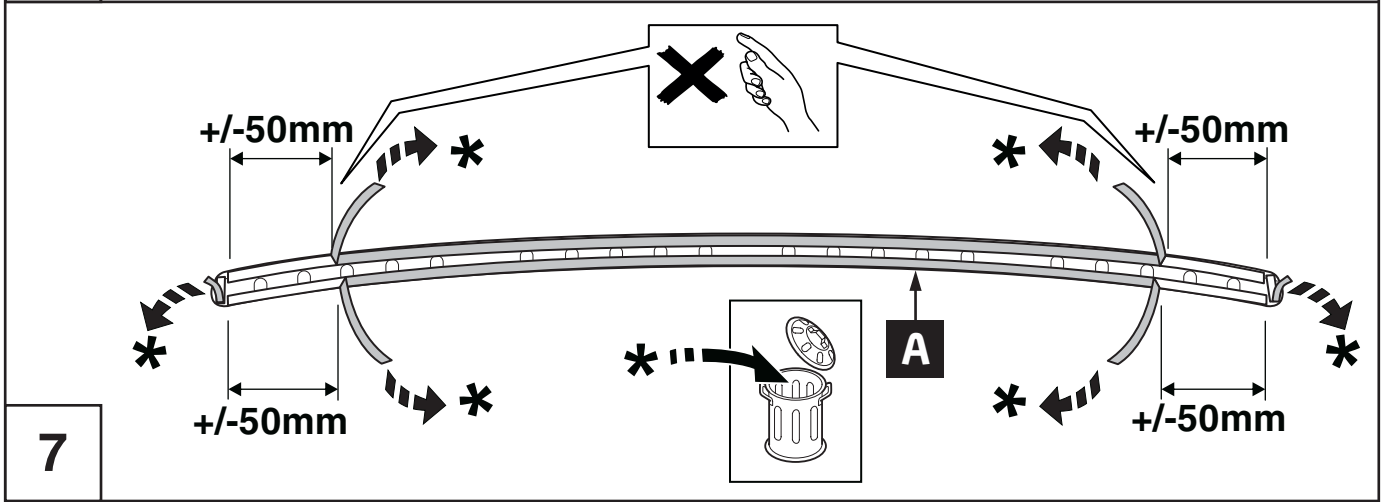

7

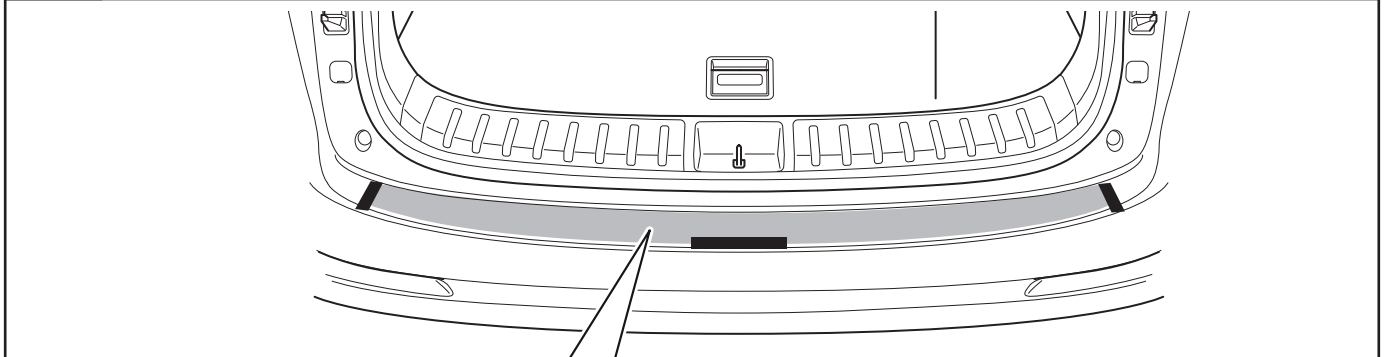

<p>1</p> <p>? °C</p>	<p>< 20°C → 2</p> <p>20°C < 40°C → 9</p>	<p>2</p> <p>+ °C</p>
<p>3</p> <p>? °C</p>	<p>20°C < 40°C → 9</p>	<p>INFO</p> <p>8 → 11</p>

8



A

<p>1</p> <p>? °C</p>	<p>< 20°C → 2</p> <p>20°C < 40°C → 10</p>	<p>2</p> <p>+ °C</p>
<p>3</p> <p>? °C</p>	<p>20°C < 40°C → 10</p>	<p>INFO</p>

9

<p>1</p> <p>DEGREASER CLEANER</p>	<p>2</p> <p>adhesion promoter PZ415-00000-00</p>	<p>3</p> <p>→ 11</p> <p>≥ 45 sec.</p>
---------------------------------------	--	---------------------------------------

10

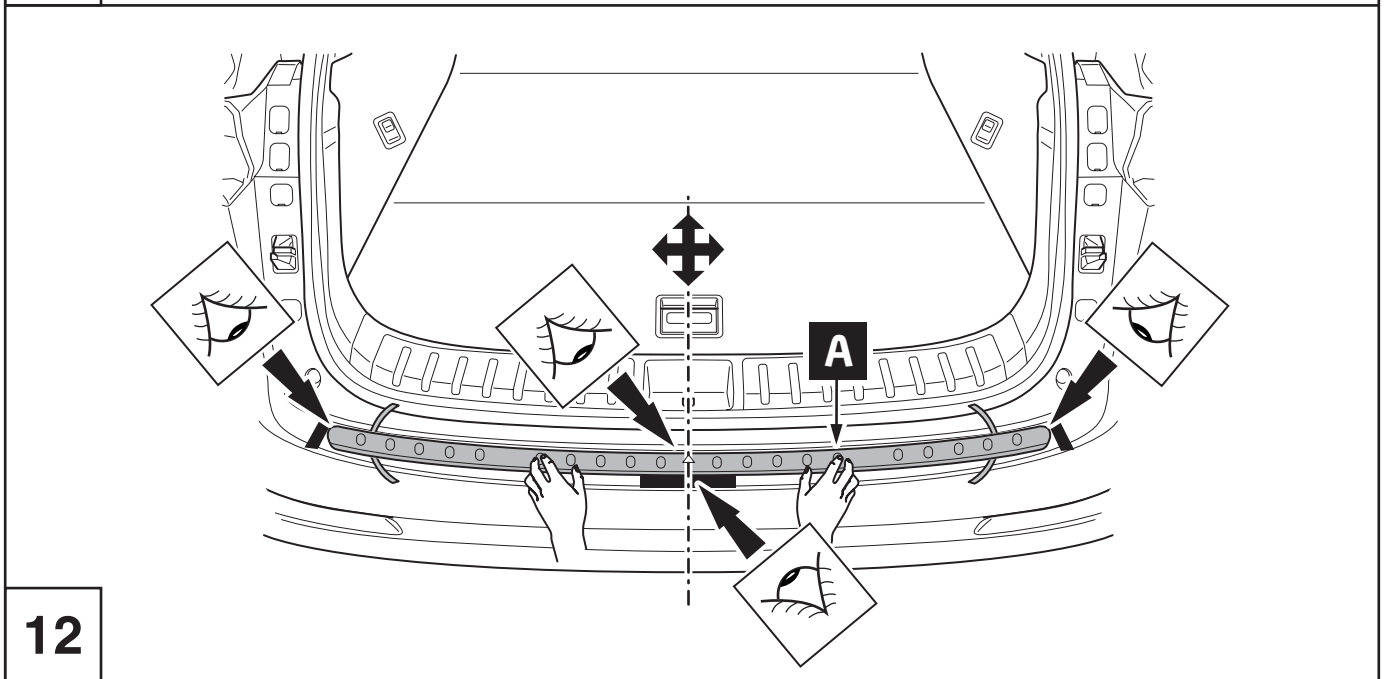
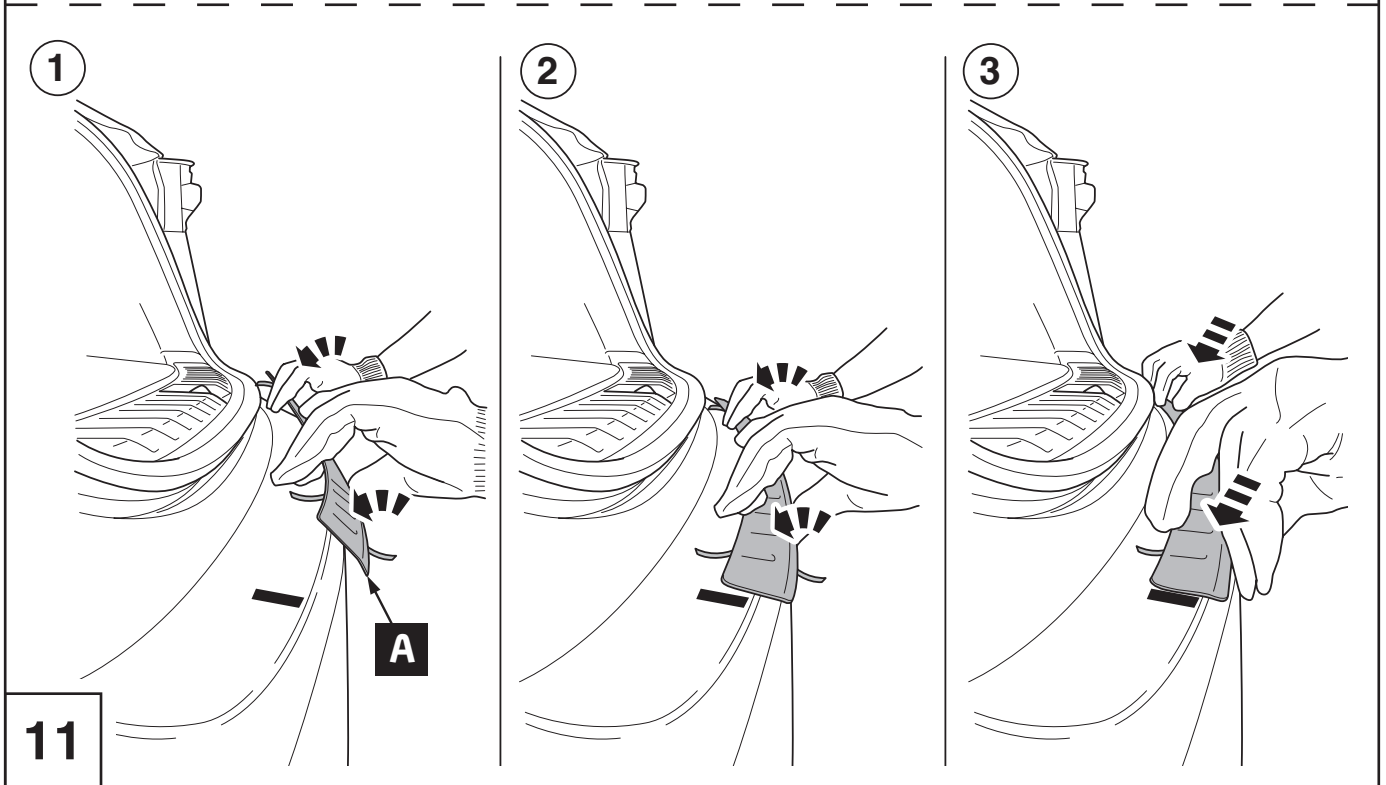
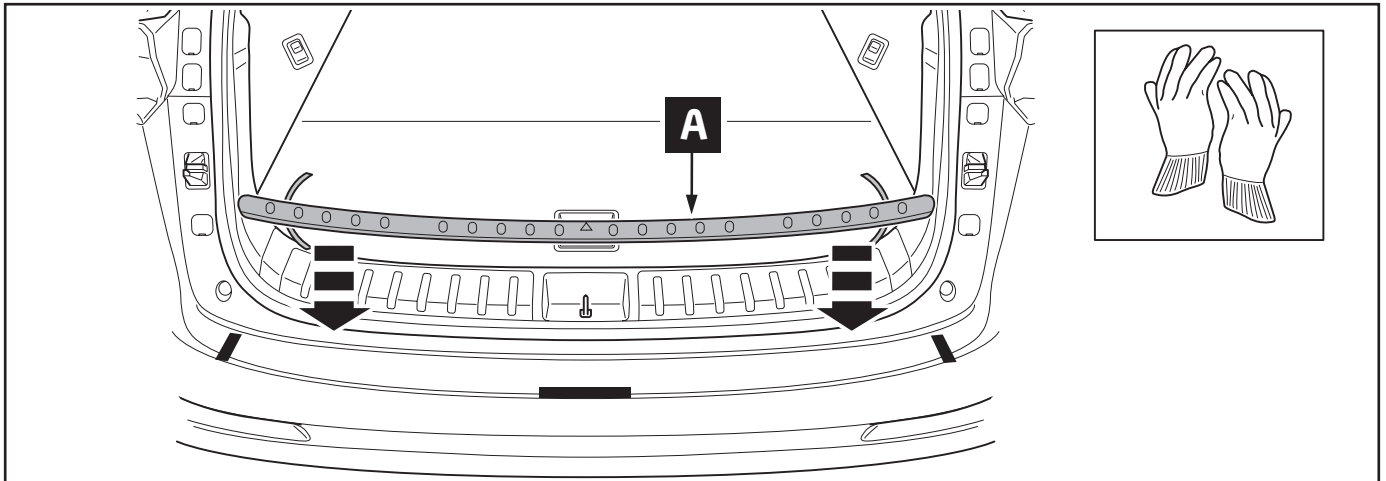

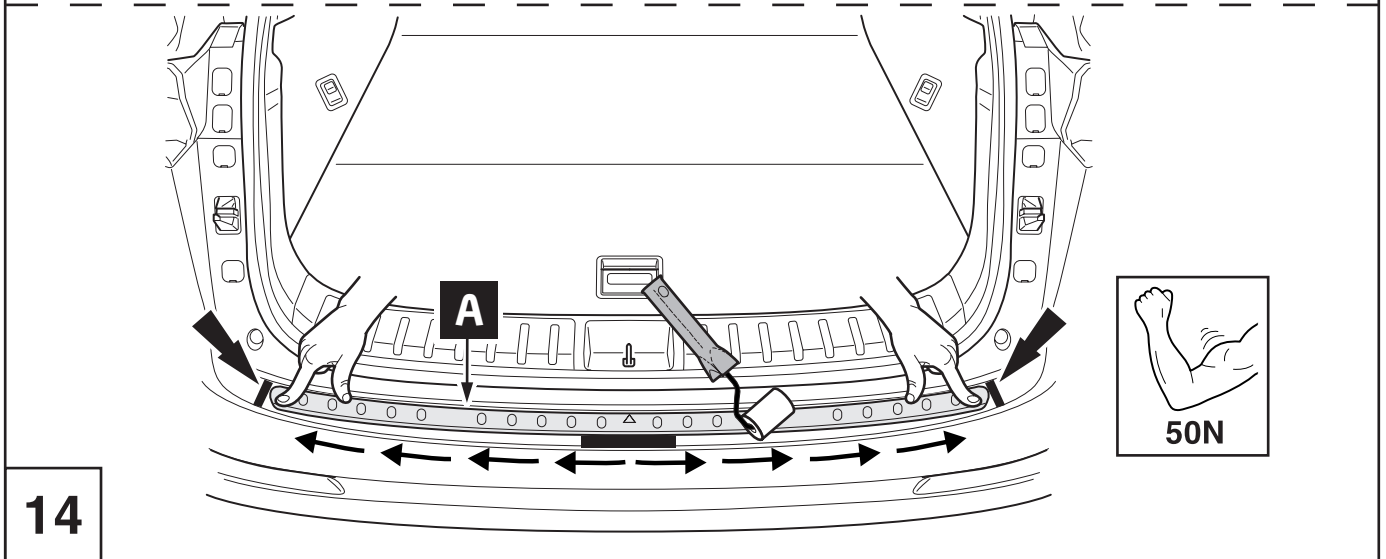
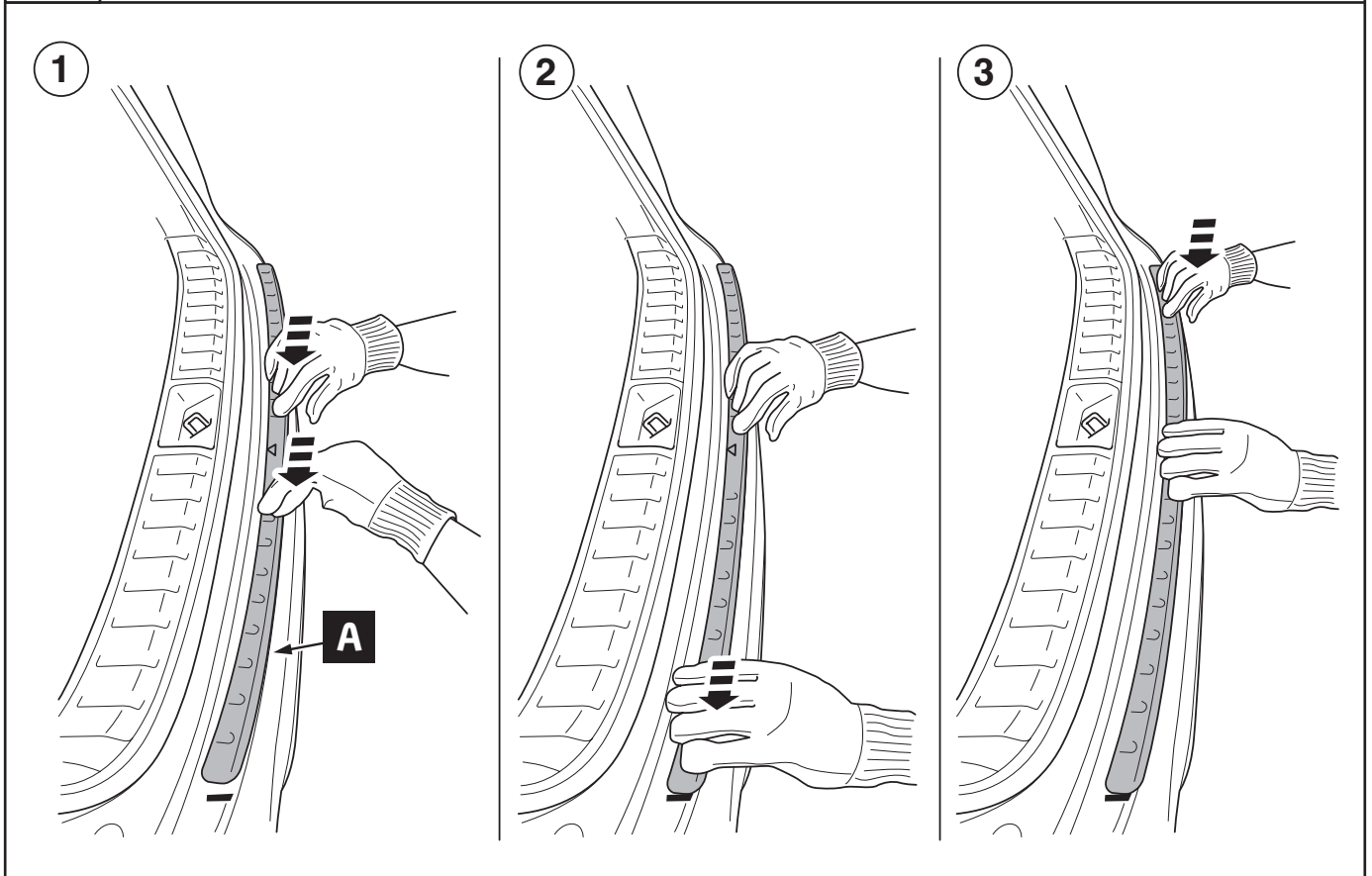
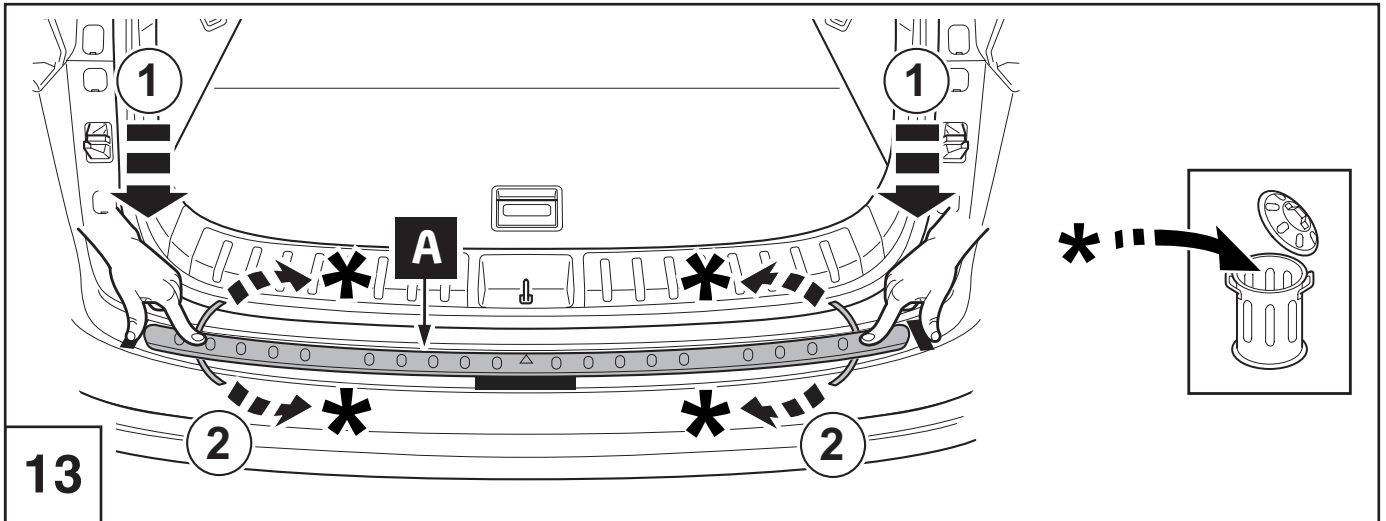

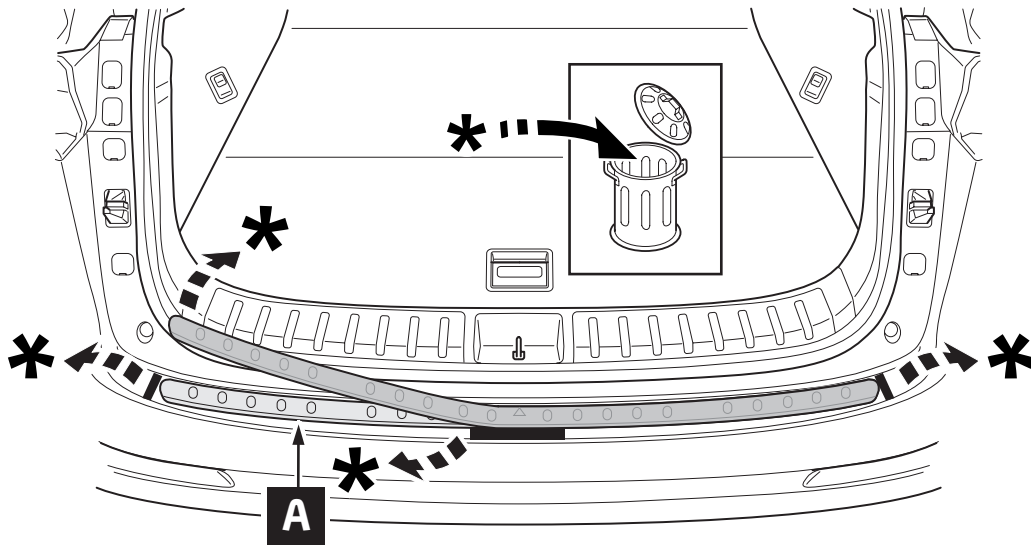

15

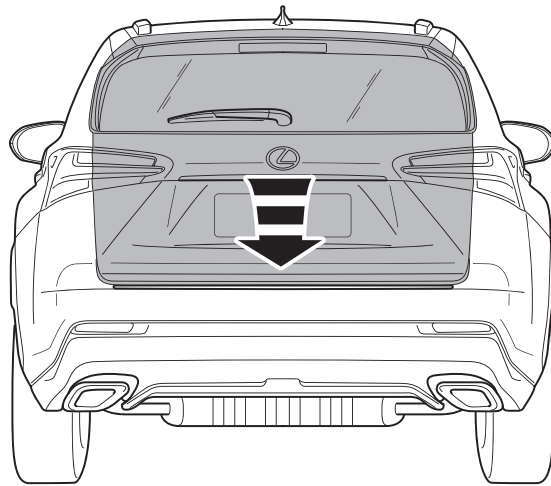

16

INFO

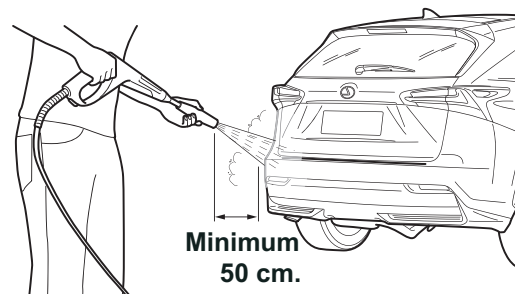
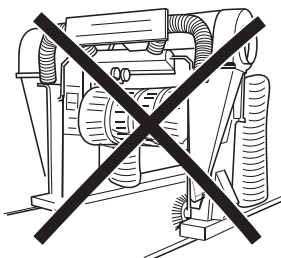
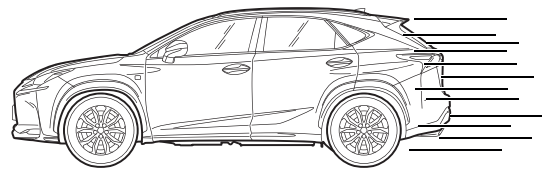
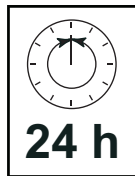

Model / Year

NX 2014/07, 2017/09

Rear bumper
protection plate

VIN n°

P/N = OK

= OK

Installation Date:
... / ... / ...

Technician Name & Signature:

Stamp: