

Door handle protection film INSTALLATION INSTRUCTIONS

Model year Universal
Part number PZ438-00182-00

Revision Record

| Rev. No. | Date | Page | Picture | Update | New | Deleted |
|----------------|------------|------|---------|-------------|-----|---------|
| 1 | 04.09.17 | 1 | | X | | |
| Rev. No. | Date | Page | Step | Remark | | |
| △ ₂ | 16.01.2019 | 5 | 5 | Model added | | |
| | | | | | | |
| | | | | | | |

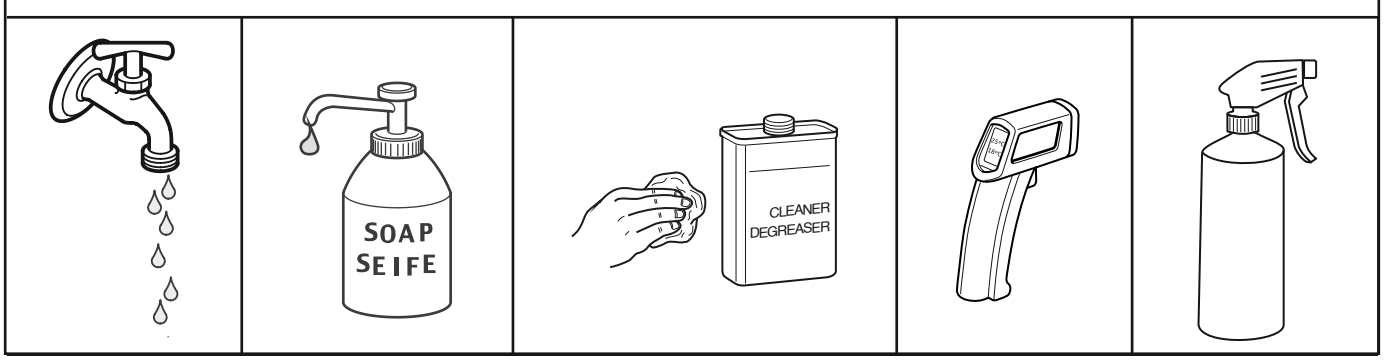
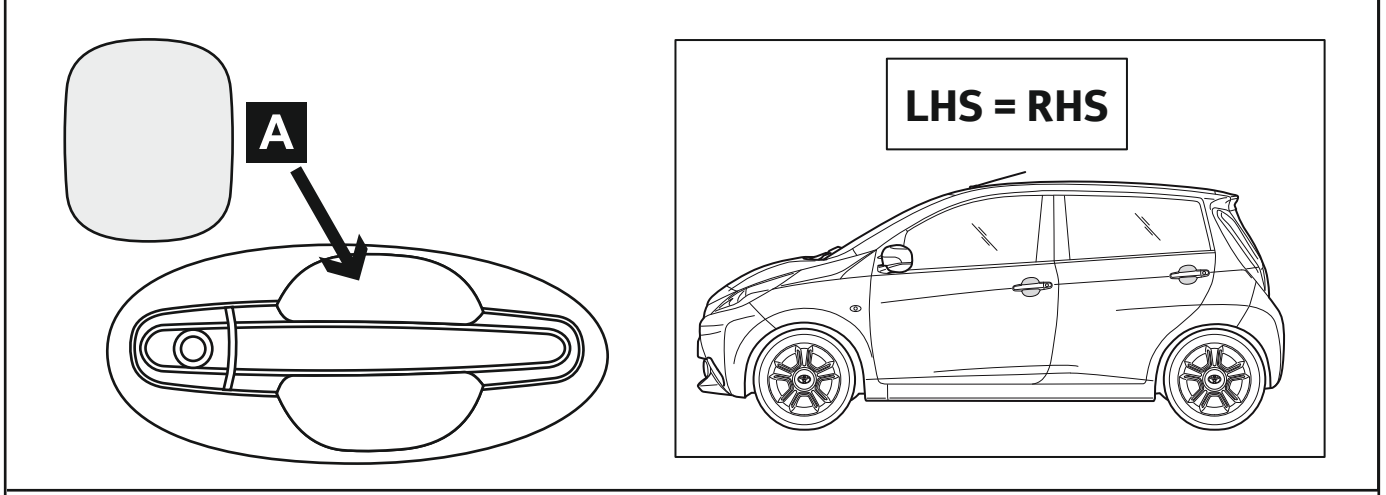
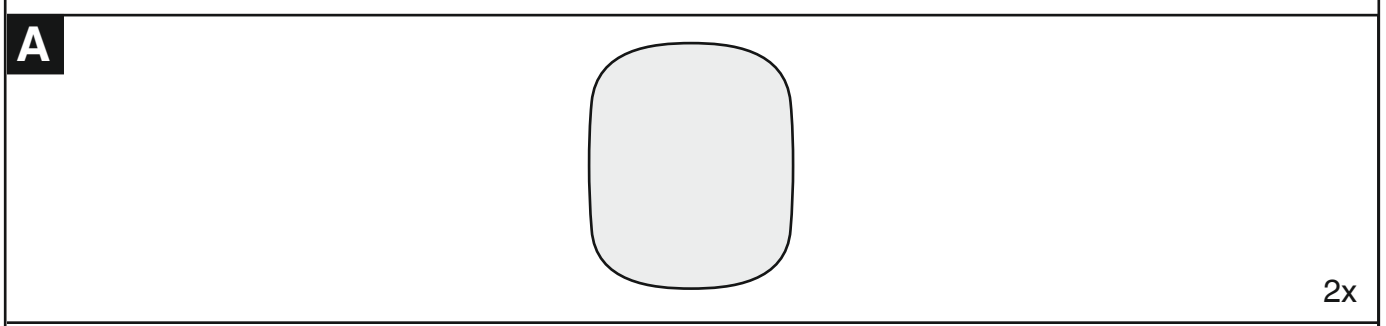



Material Safety Data Sheet

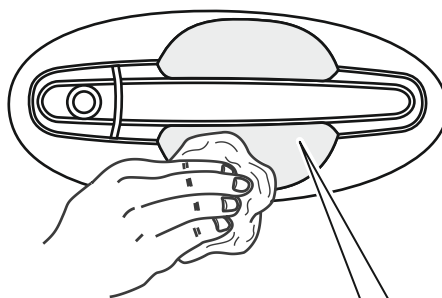
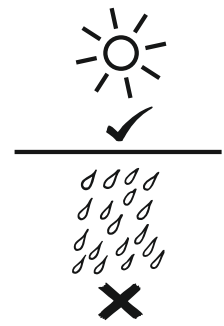
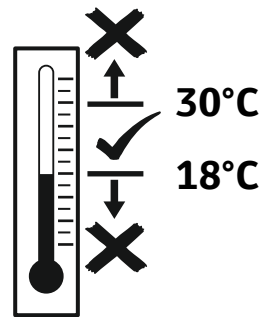
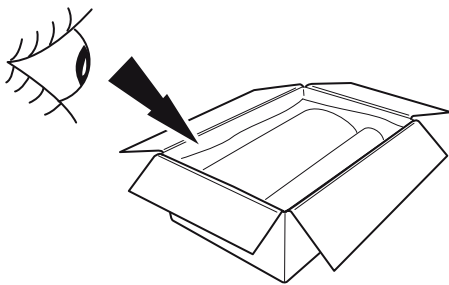
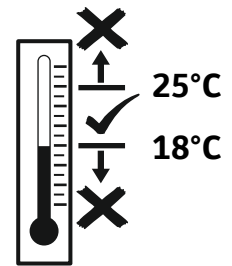
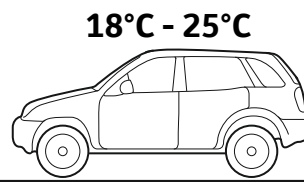
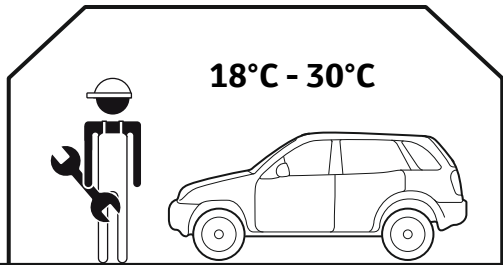

| | | |
|----------------------------------|----------|--|
| <p>1</p> <p>25°C</p> <p>18°C</p> | <p>2</p> | |
|----------------------------------|----------|--|

1

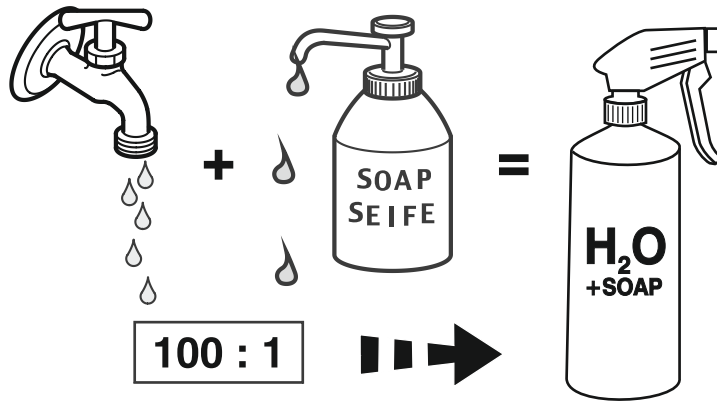

2

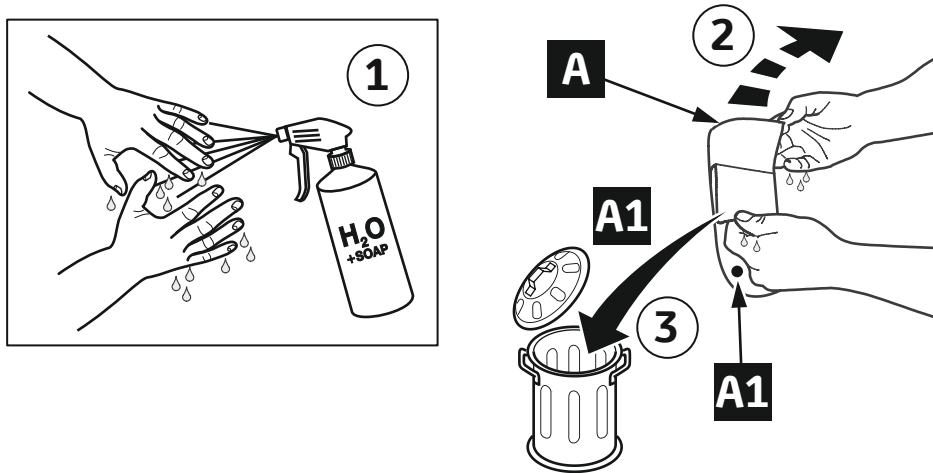

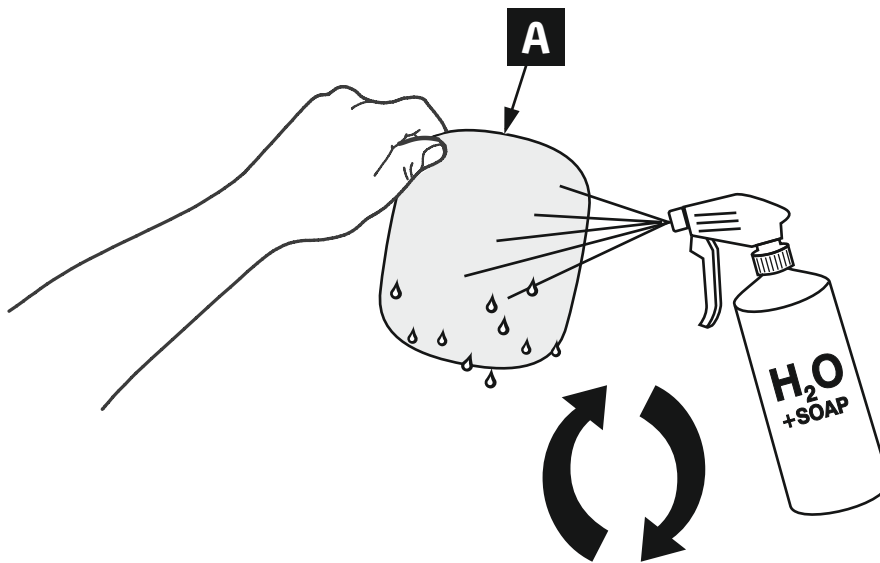

3

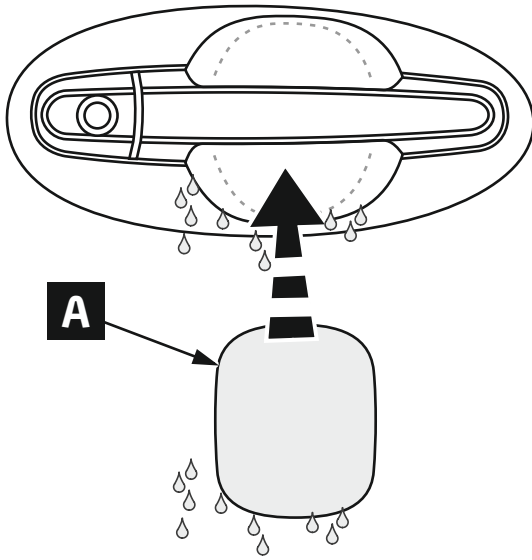

4











Lexus UX 2018/10
Land Cruiser VX
****J200*-G**E*W**

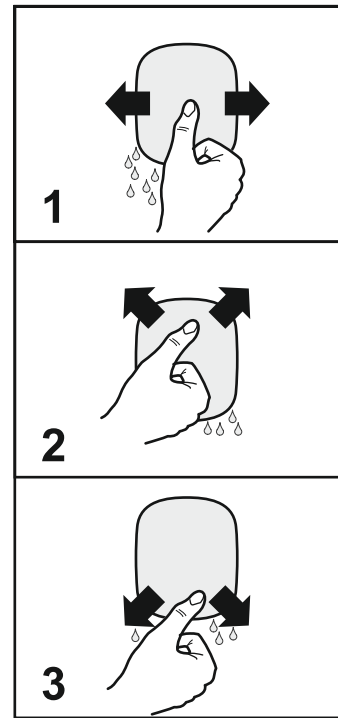
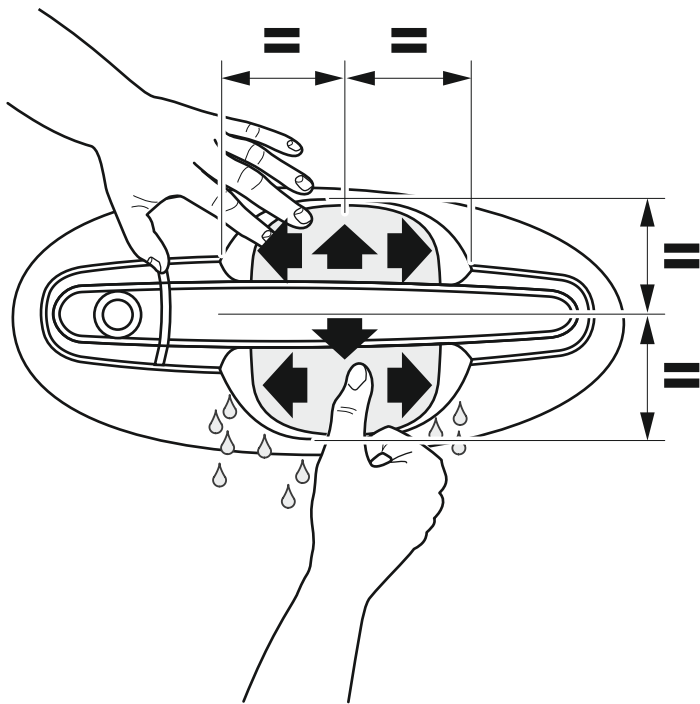

5



6

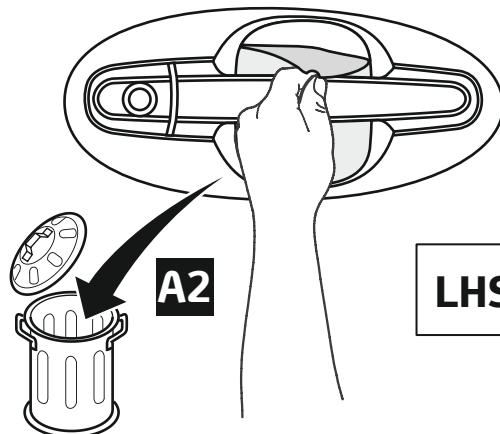

LHS = RHS

7

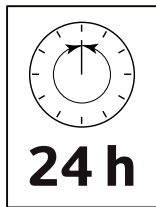
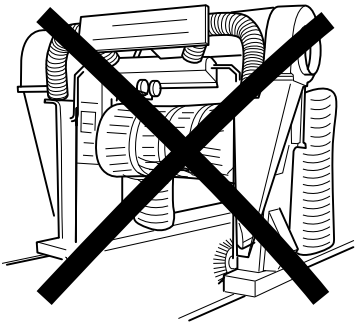
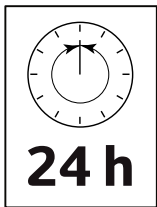

> 1 meter

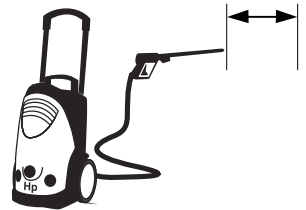

CHECK SHEET





Model / Year Universal Door handle protection film

VIN n°

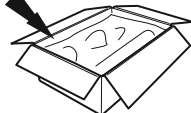
 **P/N = OK**



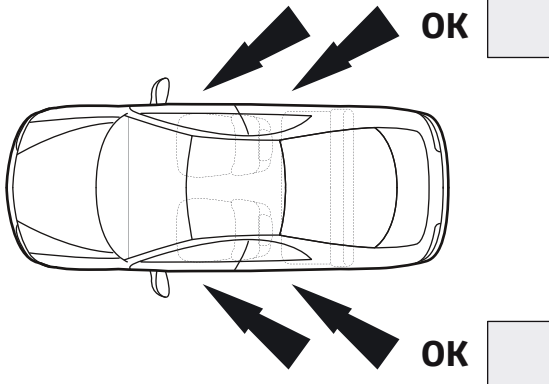
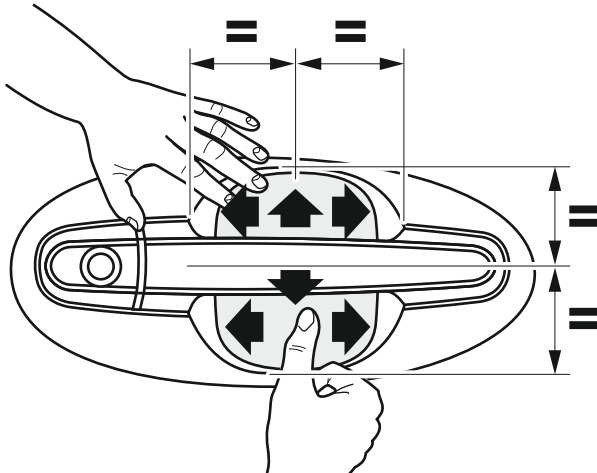

  **= OK**



OK

OK

  **= OK**

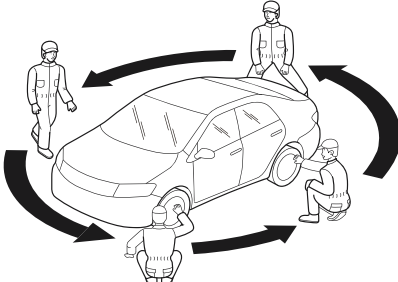

Installation Date:

. . / . . /

Technician Name & Signature:

Stamp: